

SET UP Level

To enter the SET UP level, turn on the power while pressing the key DISP.

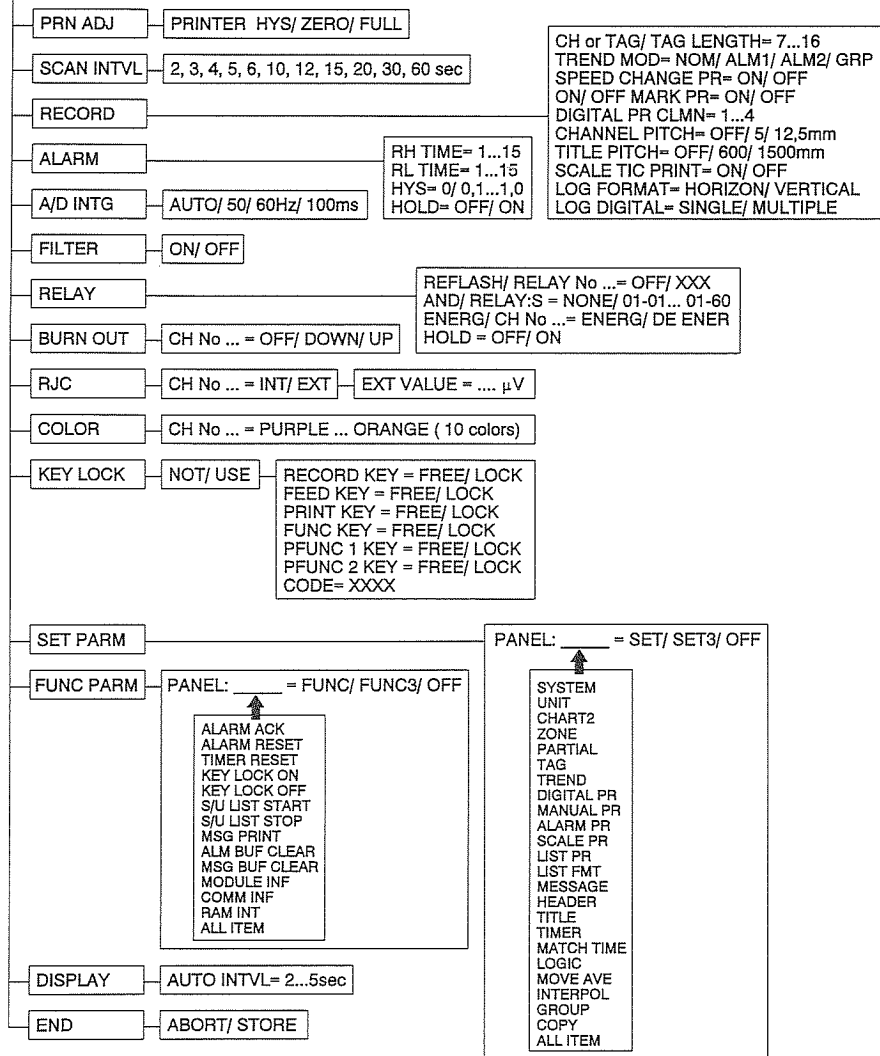

Quitt the SET UP level via menu END= STORE or ABORT.

PMA
 Prozeß- und Maschinen-Automation GmbH
 Miramstraße 87
 D-34123 Kassel
 Tel.: +49-561-5011307
 Fax: +49-561-5011710

G.960.426



Schnellanwahl Short guide Recherche rapide

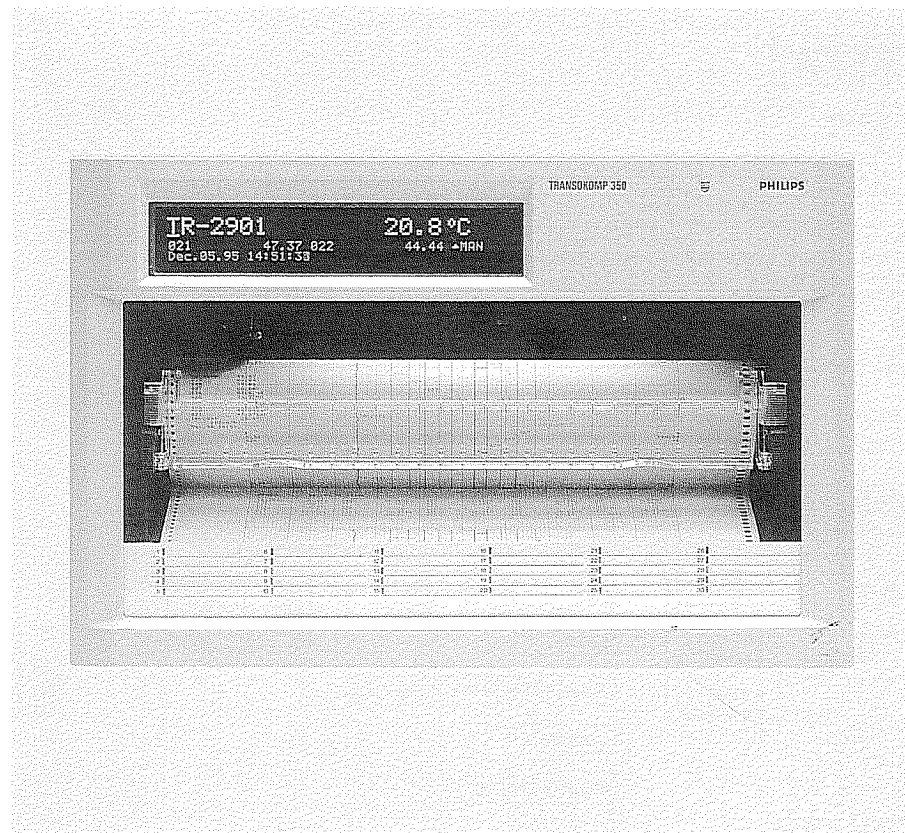

Kurzanleitung zur Bedienung des
 Short operating instructions for
 Mode d'emploi abrégé pour les enregistreurs
 Transokomp 350



**Process and
 Machinery
 Automation**

DISPLAY MODE

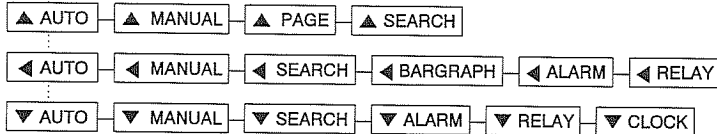

RANGE

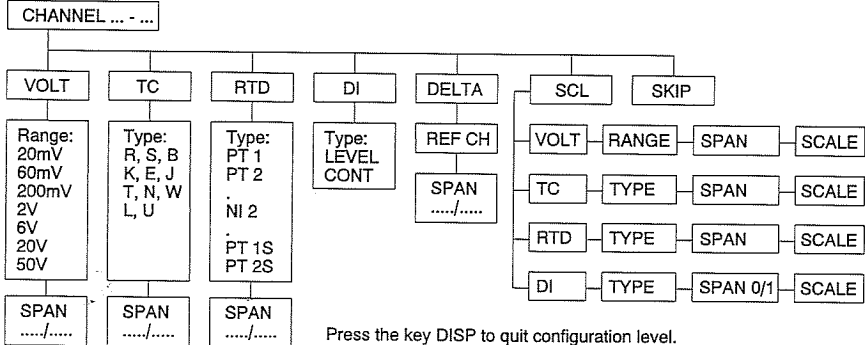

CHART

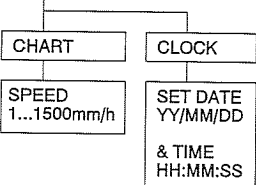

ALARM

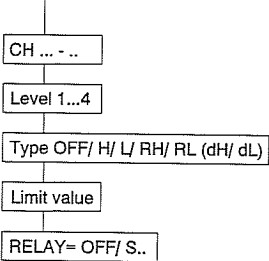

PRINT

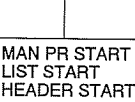

FUNC

Default setting can be modified in the SET UP menu.

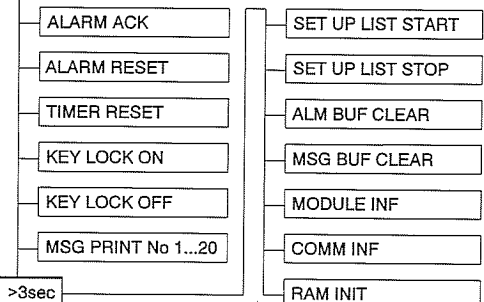

SET

Default setting can be modified in the SET UP menu.

