



Industrial controller KS92/94

KS92/94

User manual

9499 040 44811

valid from: 8365

DAC[®] is a patented method and a registered trademark of
Regeltechnik Kornwestheim GmbH.

© PMA Prozeß- und Maschinen-Automation GmbH 2000. Printed in Germany (0007).
All rights reserved. No part of this document may be
reproduced or published in any form or by any means without prior written permission
from the copyright owner.

A publication of PMA Prozeß- und Maschinen-Automation.
Subject to changes without notice.

PMA Prozeß- und Maschinen-Automation GmbH
P.O. Box 310 320
D-34113 Kassel
Germany

Contents

| | | |
|----------|---|-----------|
| 1 | General hints | 9 |
| 1.1 | Technical data | 10 |
| 1.1.1 | Safety notes | 10 |
| 1.1.2 | Electromagnetic compatibility | 10 |
| 1.1.3 | Maintenance / Behaviour in case of trouble | 10 |
| 1.1.4 | Electrical connections | 10 |
| 2 | Mounting and connection | 11 |
| 2.1 | Mounting | 11 |
| 2.1.1 | Removing the controller from the housing | 12 |
| 2.1.2 | Installing the controller in the housing | 12 |
| 3 | Electrical connections | 13 |
| 3.1 | Supply voltage connection ⑤ | 14 |
| 3.2 | Connecting the analog inputs INP | 14 |
| 3.3 | Outputs OUT | 15 |
| 3.4 | Digital inputs di | 15 |
| 3.5 | Digital outputs do1 to do6 ⑨ | 16 |
| 3.6 | Versions with integrated supply voltage | 16 |
| 3.7 | Connecting the bus interface ⑪ | 17 |
| 3.7.1 | Operation | 17 |
| 3.7.2 | Remote/local | 17 |
| 3.7.3 | Connection examples | 18 |
| 4 | Operation | 19 |
| 4.1 | Front view | 19 |
| 4.2 | Status displays | 19 |
| 4.3 | Menus 1...3 | 20 |
| 4.4 | The operating level | 20 |
| 4.5 | Parameter and configuration level | 21 |
| 5 | KS92/94 function survey | 23 |
| 5.1 | Basic hardware functions | 23 |
| 5.1.1 | Circuit board P: | 23 |
| 5.1.2 | Circuit board A | 23 |
| 5.1.3 | Circuit board B (optional) | 23 |
| 5.1.4 | Circuit board C (optional, only possible with KS94) | 23 |
| 5.2 | Survey of included function modules | 24 |
| 5.3 | Galvanic isolation | 25 |

| | | |
|----------|---|-----------|
| 5.4 | Input conditioning | 26 |
| 5.4.1 | Input circuit monitor | 26 |
| 5.4.2 | Scaling | 26 |
| 5.4.3 | Linearization | 26 |
| 5.4.4 | Additional measurements | 27 |
| 5.4.5 | Filter | 27 |
| 5.4.6 | Scanning intervals | 27 |
| 5.4.7 | Linearization error | 27 |
| 5.4.8 | Temperature compensation | 27 |
| 5.4.9 | Measurement value correction (optional) | 28 |
| 5.5 | Signal pre-processing | 29 |
| 5.6 | Inputs | 31 |
| 5.6.1 | Signal input 1 INP1 (main variable x1) (→ £.200) | 31 |
| 5.6.2 | Additional signal input 3 / INP3 (optional) (→ £.300) | 34 |
| 5.6.3 | Additional signal input 4 / INP4 (optional) (→ £.350) | 34 |
| 5.6.4 | Signal input 5 / INP5 (ratio variable x2, ext. set-point Wext) (→ £.400) | 34 |
| 5.6.5 | Signal input 6 / INP6 (auxiliary variable yp, position feedback yp) (→ £.450) | 35 |
| 5.6.6 | Digital inputs “di” | 35 |
| 5.7 | Outputs | 36 |
| 5.7.1 | Signal output 1 OUT1 (→ £.500) | 36 |
| 5.7.2 | Signal output 2 OUT2 (→ £.530) | 36 |
| 5.7.3 | Additional signal output 3 OUT3 (optional) (→ £.560) | 37 |
| 5.7.4 | Signal output 4 OUT4 (→ £.590) | 38 |
| 5.7.5 | Signal output 5 OUT5 (→ £.591) | 38 |
| 5.7.6 | Digital outputs do1 to do6 | 38 |
| 5.7.7 | Input and output survey | 38 |
| 6 | Set-point functions | 41 |
| 6.1 | Terminology | 41 |
| 6.2 | General | 41 |
| 6.3 | Detailed set-point function block diagrams | 43 |
| 6.4 | Safe set-point W ₂ | 45 |
| 6.5 | External set-point Wext | 45 |
| 6.6 | Set-point offset. | 46 |
| 6.7 | Bumplessness. | 46 |
| 6.7.1 | Set-point change | 46 |
| 6.7.2 | Set-point switch-over (w/w ₂ , Wext/Wint, w/wp, Controller ‘On’). | 47 |
| 6.8 | Tracking. | 47 |
| 6.8.1 | Set-point tracking (→ £.105) | 47 |
| 6.8.2 | Process value tracking. | 48 |
| 6.8.3 | MIN/MAX selection WSel | 48 |
| 7 | Process value calculation | 49 |

| | | |
|-----------|--|-----------|
| 7.1 | Standard controller | 49 |
| 7.2 | Ratio controller | 49 |
| 7.2.1 | Conventional ratio control: | 49 |
| 7.2.2 | Additional possibilities of ratio control with KS92/94 | 49 |
| 7.2.3 | Example for standard ratio control: | 50 |
| 7.2.4 | Material batching and mixing. | 50 |
| 7.3 | Three-element control. | 52 |
| 7.4 | Mean value | 52 |
| 8 | Correcting variable processing | 53 |
| 8.1 | Second correcting value. | 53 |
| 8.2 | Correcting variable limits. | 53 |
| 8.3 | External correcting variable limiting (override control) | 54 |
| 8.4 | Override control | 54 |
| 8.4.1 | Override control with continuous output | 54 |
| 8.4.2 | Override control with three-point stepping output | 54 |
| 8.5 | Bumpless A/M switch-over. | 55 |
| 8.6 | Motor actuator output action | 55 |
| 8.7 | Positioning output switch-off | 56 |
| 8.8 | Controller output action with sensor break. | 56 |
| 8.9 | Position feedback Y_p : | 56 |
| 9 | Special Functions | 57 |
| 9.1 | Control using a disturbance signal | 57 |
| 9.1.1 | Y_p signal. | 57 |
| 9.2 | “Rapid Recovery” | 59 |
| 9.2.1 | Y storage | 59 |
| 9.2.2 | Set-point ramp after switch-on | 59 |
| 9.3 | DAC® = Actuator monitoring. | 60 |
| 10 | Alarm processing | 63 |
| 10.1 | Alarm 1 / (limit 1) | 64 |
| 10.2 | Alarm 2 / (limit 2) | 64 |
| 10.3 | Alarm 3 / (limit 3) | 64 |
| 10.4 | Alarm 4 / (limit 4) | 64 |
| 11 | Optimizing the controller | 65 |
| 11.1 | Process characteristics | 65 |
| 11.2 | Controller characteristics | 65 |
| 11.2.1 | Signallers | 66 |

| | | |
|--------|---|----|
| 11.2.2 | Two-point controller | 67 |
| 11.2.3 | Three-point controller | 68 |
| 11.2.4 | Δ / Y / off | 69 |
| 11.2.5 | Three point stepping controller | 70 |
| 11.2.6 | Continuous controller | 71 |
| 11.2.7 | Continuous controller with position control | 72 |

12 Optimizing the controller 73

| | | |
|--------|---|----|
| 12.1 | Self-tuning | 73 |
| 12.1.1 | Process-at-rest monitoring: | 73 |
| 12.1.2 | Set-point reserve: | 73 |
| 12.1.3 | Start during automatic operation: | 74 |
| 12.1.4 | Start during manual operation | 74 |
| 12.1.5 | Self-tuning procedure with heating: | 75 |
| 12.1.6 | Self-tuning procedure with heating and cooling processes: | 75 |
| 12.1.7 | Signification of self-tuning messages MSG1/MSG2 | 76 |
| 12.2 | Optimizing empirically | 77 |
| 12.3 | Selectable adaptation (only KS94) | 78 |

13 Programmer 79

| | | |
|---------|---|----|
| 13.1 | General | 79 |
| 13.1.1 | Programmer definition | 79 |
| 13.1.2 | Segment parameter entry | 80 |
| 13.1.3 | Parameter pre-setting (default) | 80 |
| 13.1.4 | Time display | 81 |
| 13.1.5 | “Flat ramps” | 81 |
| 13.1.6 | Programs (recipes) | 81 |
| 13.1.7 | Change mode ramp/step | 83 |
| 13.1.8 | Preparation for operation and end position | 83 |
| 13.1.9 | Control signals and status messages | 84 |
| 13.1.10 | Pre-requisites | 84 |
| 13.2 | Changes in the program sequence | 85 |
| 13.3 | Bandwidth monitoring | 85 |
| 13.4 | Manual programmer operation | 86 |
| 13.5 | Search mode (⏏ , PRUP) | 86 |
| 13.6 | Behaviour after mains recovery and after removal of sensor errors | 87 |
| 13.6.1 | Memory loss (RAM) | 87 |
| 13.6.2 | Memory (RAM) available | 87 |
| 13.7 | Preset | 87 |
| 13.8 | Sensor fault. | 87 |
| 13.9 | Programmer displays | 88 |
| 13.9.1 | “Display 1” | 88 |
| 13.9.2 | “Display 2” | 88 |
| 13.9.3 | “Text 1” | 88 |
| 13.9.4 | “Text 2” | 88 |

| | | |
|-----------|--|-----------|
| 13.10 | Programmer operation. | 89 |
| 13.11 | Inputs and outputs, parameters, configuration | 89 |
| 14 | Timer | 91 |
| 14.1 | Definition. | 91 |
| 14.2 | Entry of times and timers. | 91 |
| 15 | User-defined texts | 93 |
| 15.1 | Text1 | 93 |
| 15.2 | Text2 | 93 |
| 16 | Configuration | 95 |
| 16.1 | General | 95 |
| 16.2 | Basic structure | 95 |
| 16.3 | Main groups | 98 |
| 16.4 | CONTR: Controller | 99 |
| 16.5 | SOURCE: Input signal allocation | 101 |
| 16.6 | INPUT: | 103 |
| 16.6.1 | Signal input 1 / INP1 (main variable x1) | 103 |
| 16.6.2 | Signal input 3 / INP3 (ratio variable x2 or auxiliary variable z) | 105 |
| 16.6.3 | Signal input 4 / INP4 (variable x3, ext. set-point Wext, override control ovc+/-) | 106 |
| 16.6.4 | Signal input 5 / INP5 (ratio variable x2, ext. set-point Wext). | 106 |
| 16.6.5 | Signal input 6 / INP6 (auxiliary variable Yp, feedback Yp). | 106 |
| 16.7 | OUTPT: | 107 |
| 16.7.1 | Signal output 1 / OUT1 | 107 |
| 16.7.2 | Signal output 2 / OUT2 | 108 |
| 16.7.3 | Signal output 3 / OUT3 | 108 |
| 16.7.4 | Signal output 4 / OUT4 | 109 |
| 16.7.5 | Signal output 5 / OUT5 | 109 |
| 16.7.6 | DO5,6 (digital control outputs) | 110 |
| 16.8 | ALARM: | 111 |
| 16.8.1 | Alarm 1 / (limit 1) | 111 |
| 16.8.2 | Alarm 2 (limit 2) | 111 |
| 16.8.3 | Alarm 3 (limit 3) | 111 |
| 16.8.4 | Alarm 4 (limit 4) | 111 |
| 16.9 | TUNE: self-tuning | 112 |
| 16.10 | DISP: User interface for operation | 112 |
| 16.11 | AUX: Additional functions | 113 |
| 16.11.1 | COM (serial interface) | 113 |
| 16.11.2 | Hardware | 113 |
| 16.11.3 | Forcing signal input | 113 |
| 16.11.4 | Forcing digital input | 113 |

| | | |
|--------------|--|------------|
| 16.11.5 | Forcing signal output | 114 |
| 16.11.6 | Forcing digital output | 114 |
| 16.11.7 | Hard-/Software Codenumber | 114 |
| <u>16.12</u> | <u>Examples of configuration</u> | <u>115</u> |
| 17 | Parameters | 117 |
| 17.1 | General | 117 |
| 17.1.1 | Allocation of parameters to the 'extended operating level' | 117 |
| 17.2 | Set-point function | 119 |
| 17.3 | Time function | 119 |
| 17.4 | Programmer functions. | 119 |
| 17.5 | Alarm function | 120 |
| 17.6 | Self-tuning | 120 |
| 17.7 | Control algorithm | 121 |
| 17.8 | Input processing | 122 |
| 17.8.1 | Process value handling. | 122 |
| 17.8.2 | Signal pre-processing | 122 |
| 17.9 | Miscellaneous. | 123 |
| 17.10 | Signals. | 123 |
| 18 | Versions | 125 |
| 18.1 | Industrial controller KS92 | 125 |
| 18.2 | Industrial controller KS94 | 126 |
| 18.3 | Input and output allocation with pre-configured units. | 127 |
| 19 | Terminology explanation | 129 |
| 20 | Index. | 133 |

1 General hints

Industrial controllers KS92 and KS94 belong to a new generation of microcomputer-based controllers in the upper performance class.

Despite their versatility, these controllers are easy to operate. Not only “slow” thermal processes, but also pressure and flow with short reaction times can be controlled without problems. Due to measuring and control functions configurable within wide limits, the controllers can be used for a wide range of application.

Safe, reliable control within close tolerances, and high plant availability are pre-requisites for economic production.

Controllers with reliable and robust control algorithms are the basis for stable process conditions, also with varying operating parameters.

A self-tuning function ensures short start-up times. The “thinking” operator guidance system with standard symbols, plain-language texts plus software and hardware interlocks prevent operating errors and thus reduce downtimes.

Controllers KS92 and KS94 are configurable as signallers, 2-point, 3-point, 3-point stepping and continuous controllers. Moreover, the output functions can be configured for $\Delta/Y/off$, position control, split-range control and numerous 3-point combinations of switching/continuous control.

Control modes are set-point, set-point/cascade and programmer, each with the possibility of set-point offset. The effect of offset can be additive (e.g. reduced stand-by set-point) or a factor (e.g. O₂ correction or split load).

Offset can be triggered by an external contact, whereby the value is defined via an analog signal or via an adjustable parameter.

Additional control modes:

- Ratio control
(stoichiometric combustion, mixing ratios, additives, batching, ...)
- Three-element control
(level control in a steam boiler, ...)
- Mean value calculation from two process values.

Apart from a correcting function for the measurement signal, it is possible to scale, linearize or square-root every input and output signal. This enables the controller to be matched precisely to the application without any supplementary equipment.

For every-day practice, feed-forward control has proved very useful to line out disturbances, e.g. with steam-generating plants. For applications where several controllers act on a single actuator, the output limiting function is recommended. Alternatively, preset output limits can be used. This not only applies for continuous outputs, but also for switching and three-point stepping outputs (motor control).

1.1 Technical data

The technical data are given in data sheet no. 9498 737 28333.

1.1.1 Safety notes

Following the enclosed safety instructions 9499 047 07101 is indispensable!

The insulation of the instrument conforms to EN 61 010-1 with pollution degree 2, overvoltage category III, operating voltage 300 V and protection class I. Additional with horizontal installation, a protection to prevent live part, e.g. wire ends, from dropping into the open housing of a withdrawn controller must be fitted.

1.1.2 Electromagnetic compatibility

The instrument conforms to **European Directive 89/336/EEC** and will be provided with the CE-marking. The following European Generic Standards are met: **Emission: EN 50081-2** and **Immunity: EN 50082-2**. The unit is suitable for use in industrial areas (in residential areas, RF interference may occur). The electromagnetic radiation can be reduced decisively by installing the unit in a grounded metal switch cabinet.

1.1.3 Maintenance / Behaviour in case of trouble

The controller needs no maintenance. The rules to be followed in case of trouble are:

- Check mains (voltage, frequency and correct connections),
- check, if all connections are correct,
- check the correct funktion of the sensors and final elements,
- check the configuration words for required functions and
- check the adjusted parameters for required operation.

If the controller still does not work properly after these checks, shut down the controller and replace it.

Cleaning:Housing and Front can be cleaned by means of a dry, lint-free cloth. No use of solvents or cleansing agents!

1.1.4 Electrical connections

- The electrical connections must be made according to the connecting diagram. For R.F. interference suppression, the mains cables must be kept separate from all other cables.
- The protective earth, which is to be taken to terminal A11 (P13 with continuous controllers) must be grounded via a lead which should be as short as possible (15 cm during test).
- When connecting a contactor to the relay output, an RC protective circuit is required to prevent high voltage peaks which might cause trouble to the controller.

2 Mounting and connection

2.1 Mounting

The mounting position of controllers KS92 and KS94 is uncritical. Sufficient space for mounting should be provided on the rear of the control panel.

The controller mounting procedure is as follows:

- Mark and realize the panel cut-out as shown in the drawing below.
- Insert the housing into the panel cut-out from the front.
- Fit a fixing clamp to the controller top so that it locks into one of the housing cut-outs. Tighten it slightly using a screwdriver.
- Fit the second fixing clamp accordingly on the controller bottom, in diagonal position to the upper fixing clamp.
- Tighten the two fixing clamps, until the housing is seated firmly without distortion.

For reaching **protection type IP65** between controller and panel, an additional sealing ring must be provided. Moreover, two further fixing clamps are required. The mounting material required for this purpose can be delivered on request.

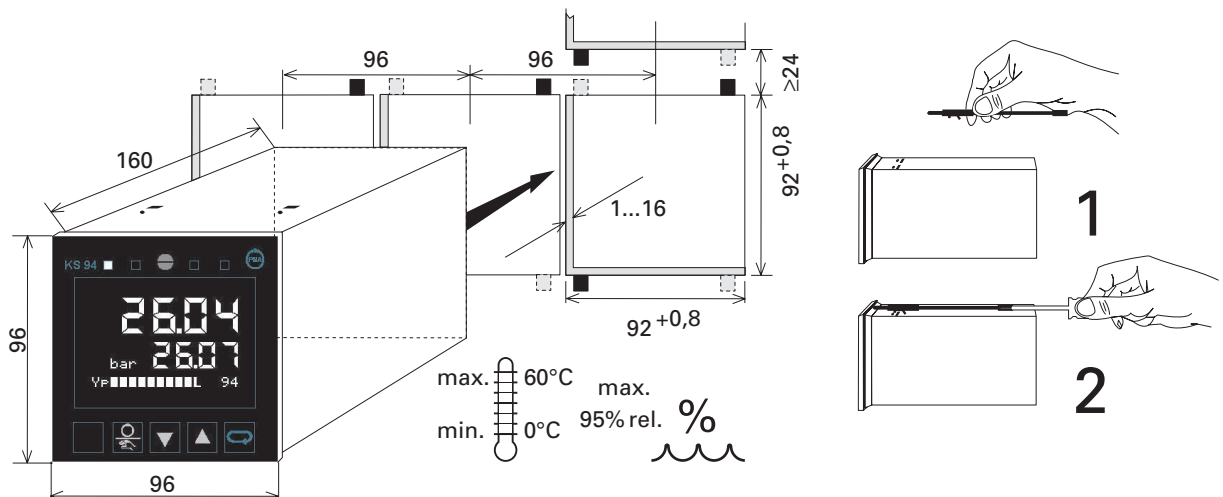

S.I.L. switch: with the switch closed, transition to parameter and configuration level is disabled. When making an attempt to change over to the parameter level, "Paral" is displayed (text1). Correcting variable, set-point and parameters at the "extended operating level" remain available for selecting and changing. For access to the S.I.L. switch, release the locking screw and withdraw the instrument module from the housing. Subsequently, re-insert the controller module into the housing and mount it with screws.

 **Caution!** The instrument contains ESD-hazarded components.

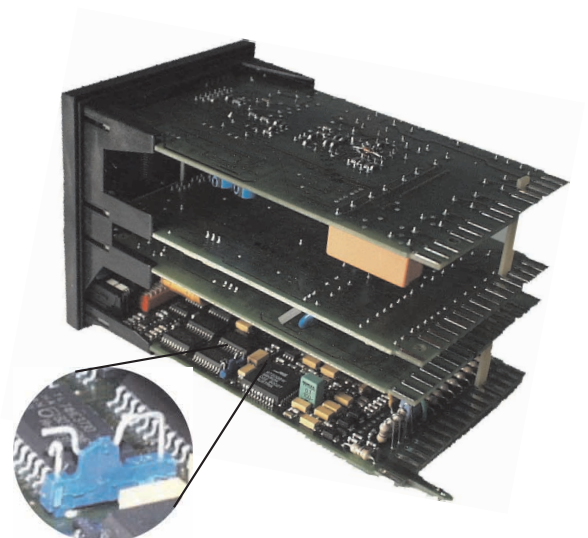

2.1.1 *Removing the controller from the housing*

For maintenance and service purposes, the controller module can be removed from the housing, whereby the housing with the relevant wiring remains in the installation.



If the operating voltage is switched on during this procedure, the live terminals in the controller housing must be protected against contact.



The controller electronics contains electrostatically sensitive components. Static discharge must be prevented by suitable measures.



When removing several controllers, take care that the controllers are re-mounted into the correct housings! For this, not only the hardware, but also the data configured in the controller are decisive.

For dismantling the controller module from the housing, remove the captive screw on the controller front. Hereby, the module is released from the housing, until it can be removed.

2.1.2 *Installing the controller in the housing*

Note that each specific controller module belongs to a particular housing.

Insert the module carefully into the housing guide rails in the correct mounting position and slip it in position without pressure. A small remaining gap between front and frame is correct. Tighten the screw on the controller front, until the module is firmly locked in position.

3 Electrical connections

- The electrical connections must be made according to the connecting diagram. For R.F. interference suppression, the mains cables must be kept separate from all other cables.
- The protective earth, which is to be taken to terminal A11 (P13 with continuous controllers) must be grounded via a lead which should be as short as possible (15 cm during test).
- When connecting a contactor to the relay output, an RC protective circuit is required to prevent high voltage peaks which might cause trouble to the controller.

The controller is provided with flat-pin connectors 1 x 6,3 mm or 2 x 2.8 mm for electrical connection.

Connecting diagram:

galvanic isolation

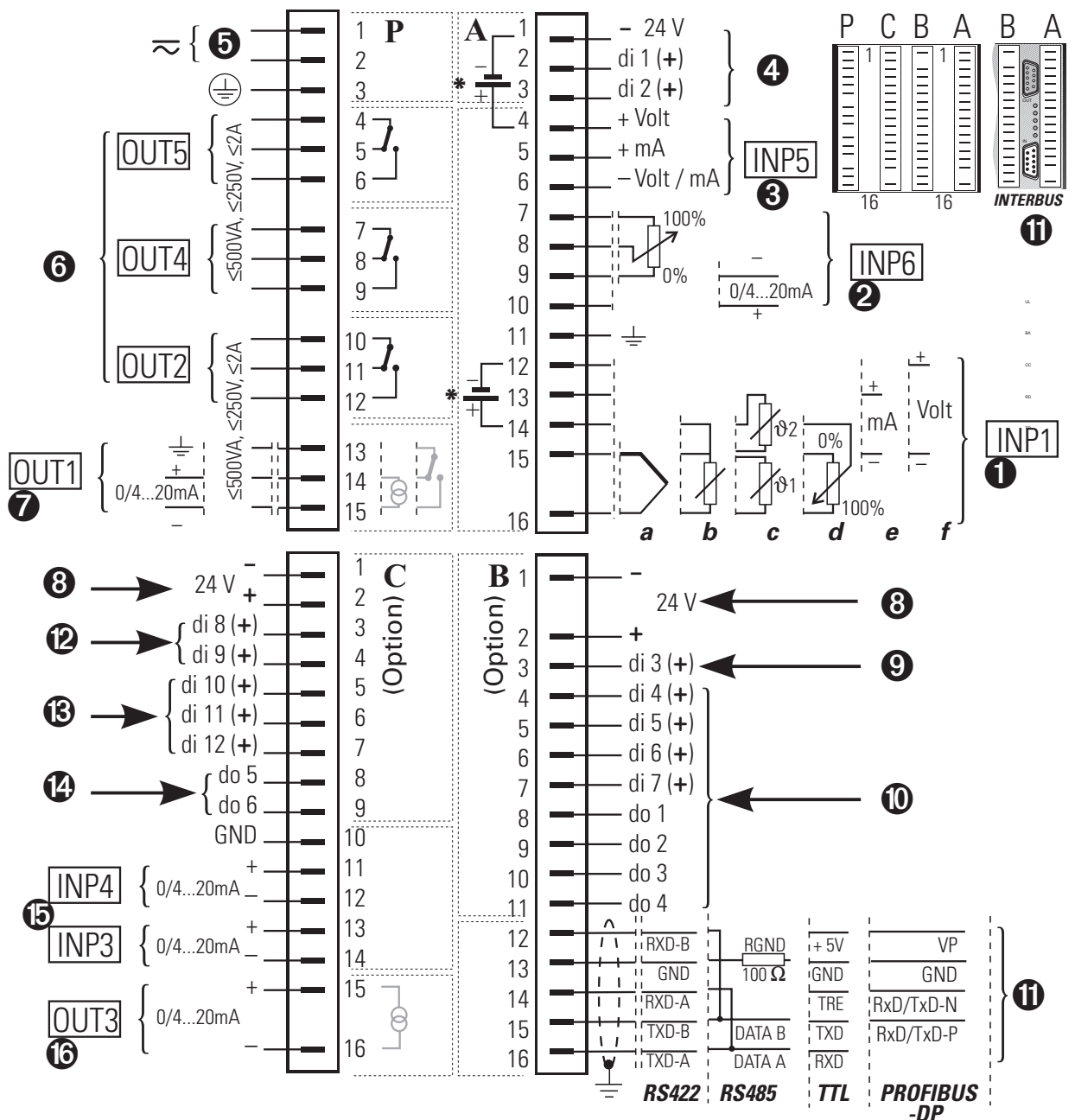

* Versions with integrated supply voltage (connection example look at page)

3.1 Supply voltage connection ⑤

The following controller versions are available:

AC versions

- 90...260 V AC (KS92 only 230 V AC)
Frequency: 48...62 Hz
Power consumption: approx. 10 VA

24 V UC versions (only KS 94)

- 24 V AC , 48...62 Hz
The voltage limits are 24 V AC. (+10...-15 %)
- 24 V DC
With the 24 V DC version, the limits are within 19,2 and 30V.

3.2 Connecting the analog inputs INP

X1 **Input INP1 ①**
Input for variable x1. (see page 31 ff)

- a Thermocouple
- b Resistance thermometer (PT100 in 3-wire connection)
- c Temperature difference as 2 • PT100 in 2-wire connection
- d Potentiometric transducer
- e Current
- f Voltage

X2 **Input INP3 ⑤**
Dependent of configuration, this input is used for variable x2 or variable z.
The reference potential (GND) of this input is at terminal C10 (see page 34).

X3 **Input INP4 ⑤**
Dependent of configuration, this input is used for variable x3, external set-point or override control (OVC).
The reference potential (GND) of this input is at terminal C10 (see page 34).

X2 **Input INP5 ③**
This input is used for variable x2, for the external set-point or for external set-point offset (configuration level L. 180).
With voltage signals, A6 must be connected with the reference potential at A9 (see page 34)

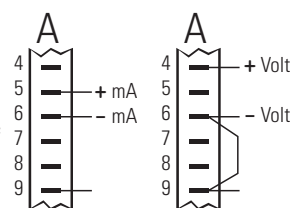

Input INP6 ②

This input is used for position feedback with 3-point stepping controllers, for the external set-point or for the external set-point offset (configuration level L. 180) (see page 35)

3.3 Outputs OUT

Output OUT1 ⑦

Dependent of version, OUT1 is a continuous, a logic or a relay output. It may be allocated to Y1 or to alarm. With logic and continuous output, a protective earth must be connected to P13. The logic signal switches between 0 and 20 mA (load $\leq 600 \Omega$) or 0 / > 12 V (load $\geq 600 \Omega$) (see page 34).

Outputs OUT2, OUT4 and OUT5 ⑥

These outputs are relay outputs. Output OUT2 is configured either for y2 or for alarm (see page 38). Outputs OUT4 and OUT5 are allocated to alarms LIM1 / LIM2.

With programmers, they can be configured in addition to outputs 1...4 or for program end (€.590 / €.591) (see page 38).

Output OUT3 ⑩

Dependent of configuration, OUT3 is a continuous or a logic output. The logic signal switches between 0 and 20 mA (load $\leq 600 \Omega$) or 0 and 12 V (load $\geq 600 \Omega$).

Which signal shall be taken to this output must be determined at configuration level. Selection between various controller outputs, process values and set-point is possible (see page 37).

3.4 Digital inputs di

Digital inputs di1 and di2 ④

Dependent of configuration (€.190 and €.191), inputs di1 and di2 can control the following procedures:

- Switch-over between internal set-point **W** (0) and external set-point **Wext** (1)
- Switch-over between internal set-point **W** (0) and second set-point **W2** (1)
- Switch-over between automatic (0) and manual (1) operation
- Set-point offset switch-on; normal (0) offset (1)
- Switch-over between normal correcting value (0) and safety correcting value (1)
- Controller switch-ON (0) or OFF (1)
- Switch-over between PI (0) and P (1); with 2/3-point and continuous controllers or feedback switch-off with 3-point stepping controllers
- Bumpless switch-over between normal correcting value (0) and safe correcting value (1)
- Bumpless switch-over to internal set-point (tracking only di2) OFF (0) ON (1)

Digital inputs di3 to di12 ⑨⑩⑫⑬

di3 used for switch-over between local (0) and remote (1).

di4 used for switch-over between program STOP (0) and START (1) (€.192; SPrSt).

di5 used for programmer RESET; normal (0), reset (1).

di6/di7 used for program number selection with programmer.



| | | | |
|----------|---|---|---|
| di6 | 0 | 1 | x |
| di7 | 0 | 0 | 1 |
| Programm | 1 | 2 | 3 |



| | | | | |
|---------------|---|---|---|---|
| di8 | 0 | 1 | 0 | 1 |
| di9 | 0 | 0 | 1 | 1 |
| Parameter set | 0 | 1 | 2 | 3 |

di7/di8 used for program number selection with programmer.

di10 minimum delimitation of the correcting variable with 3-pnt.stepping controller

di11 maximum delimitation of the correcting variable with 3-pnt.stepping controller and can be configured for switching on the effective set-point offset (€.190: SdWor).

di12 switches over bumplessly to the internal set-point (tracking) OFF (0) ON (1).

and can be used for switching over to the second set-point W2 (€.190) OFF (0) ON (1).

3.5 Digital outputs do1 to do6 ⑨

- do1 indicates the status of control output 1 with programmer.
- do2 indicates the status of control output 2 with programmer.
- do3 indicates the status of control output 3 with programmer.
- do4 indicates the status of control output 4 with programmer.
- do5 indicates, if the controller is in manual or automatic mode, or the Y1 condition with switching controllers (Ł.5 9 6).
- do6 indicates, if the controller uses the external or the internal set-point, or status Y2 with switching controllers (Ł.5 9 7).

3.6 Versions with integrated supply voltage

The supply voltage can be used only for energization of a 2-wire transmitter or for energization of max. 4 control inputs. The supply voltage is potential-free and can also be used for energizing inputs INP3 ... INP6 or for other units. Selection of supply voltage or digital inputs is by S.I.L. switches (see figure opposite).

| | Transmitter supply voltage | Digital input |
|---|----------------------------|---------------|
| ① | Position T | Position D |
| ② | open | closed (D) |
| ③ | closed (T) | open |

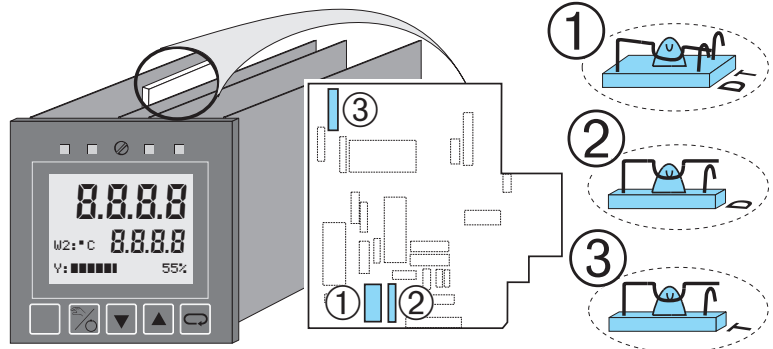

The supply voltage is only applied to terminals A12 and A14 with INP1 configured for **current** or **thermocouple** (Ł.2 0 0 ; Ł.9 F e) and the S.I.L. switches set for transmitter supply (factory setting)! With the S.I.L. switches set to digital input, the voltage is applied to terminals A1 and A4 independent of the configuration of input INP1. In this case, the voltage input of INP5 is not available.

Connection of a 2-wire transmitter on example of INP1 or INP5

Supply voltage for energization of digital input (e.g. di1...di4)

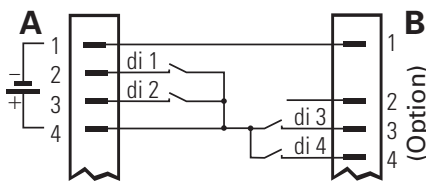

External use of the supply voltage

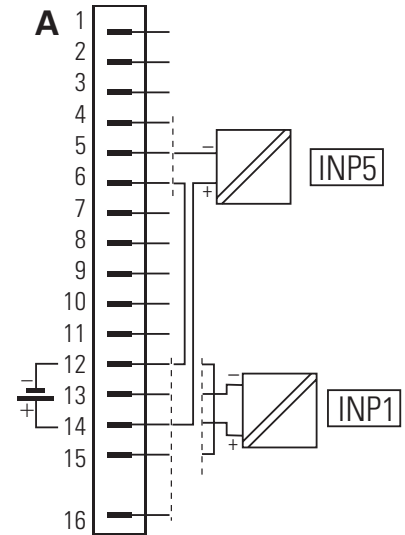
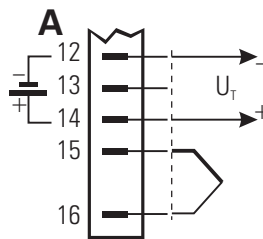

3.7 Connecting the bus interface ⓘ

TTL or RS422 or RS485, PROFIBUS or INTERBUS. With TTL, an interface module for conversion to RS422/RS485 is required. 4 units may be connected to an interface module.

3.7.1 Operation

KS94 data can be read, or displayed and modified from the front-panel PC interface or via the serial interface.

After delivery of controller KS94, the PC interface is active. KS94 configuration and parameter setting are supposed to be done by means of the engineering tool before commissioning.

Switch-over to the serial interface is either

- via operator dialogue (front):
 - press ≥ during 3 sec. → **Para** flashes
 - press until **CBus** flashes → confirm briefly.
 - press ≥ during 3 sec. → **Para** flashes
 - press until **CFrnt** flashes → confirm briefly.
- or by activating 'REMOTE' (→ page 17). Switching back to LOCAL does not cause switch-over to the front-panel interface.

| | |
|----------------------|--|
| display CBus | △ switch over to rear interface |
| display CFrnt | △ switch over to front-panel interface |

Switch-over to the PC interface is only possible with the R/L input set to LOCAL.

3.7.2 Remote/local

Units with serial interface are fitted with a hardware input (di3) for switch-over between REMOTE and LOCAL operation (R/L).

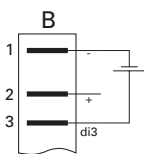

During 'REMOTE' all operations via the serial interface (writing and reading) are permissible. The following operations are still possible via the keys of the local operating front panel:

- Display switch-over
- Display of parameters without modification
- Display of configuration data without modification

During remote operation, the PC interface cannot be operated. When switching over from LOCAL to REMOTE, an active PC interface is switched off.

During 'LOCAL', only reading of all data via the serial interface is permissible. Modifications are not possible, exception:
 any data related only to the interface or which are not adjustable local via local operation.



3.7.3 Connection examples

Fig.: 1 TTL-interface connection

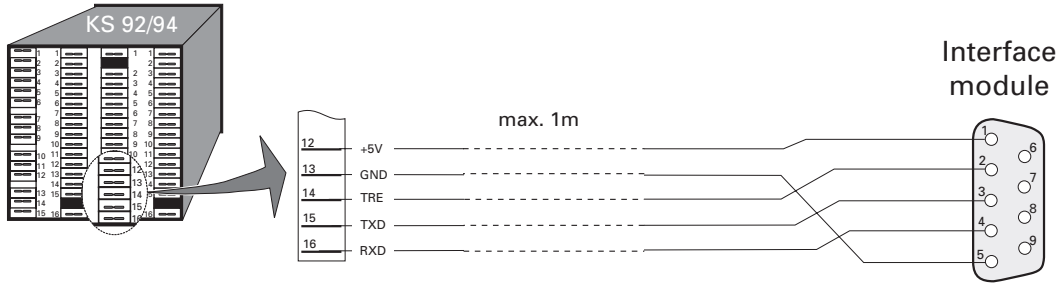

Fig.: 2 RS422-interface connection

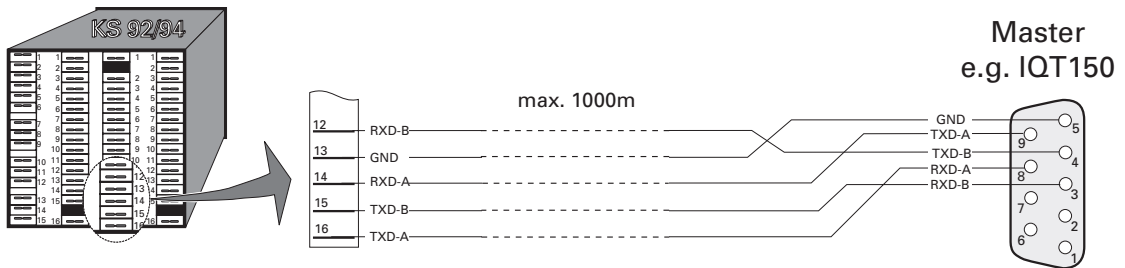

Fig.: 4 RS485-interface connection



Fig.: 3 PROFIBUS-DP connection

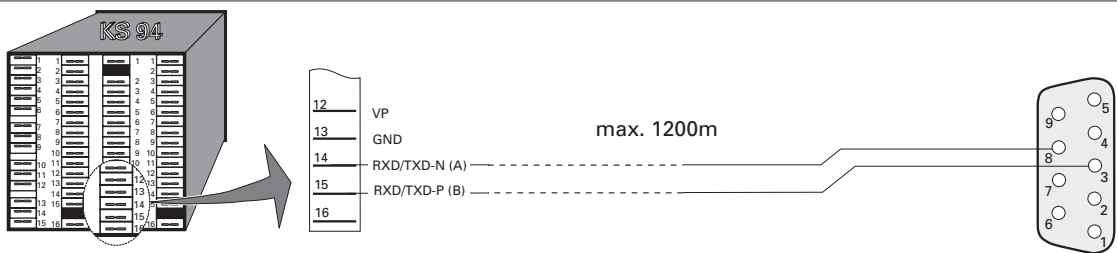
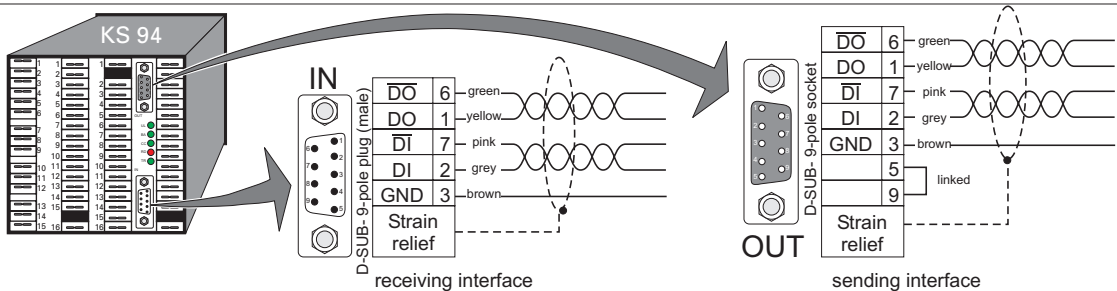

Fig.: 5 INTERBUS connection



4 Operation

4.1 Front view

Fig.: 6 Front view

LED 2 e.g. Cooling
LED 1 e.g. Heating
Locking screw

Text 1 e.g. physical unit

Text 2 e.g. Bargraph / Dialogue

PC interface

Manual/Automatic key

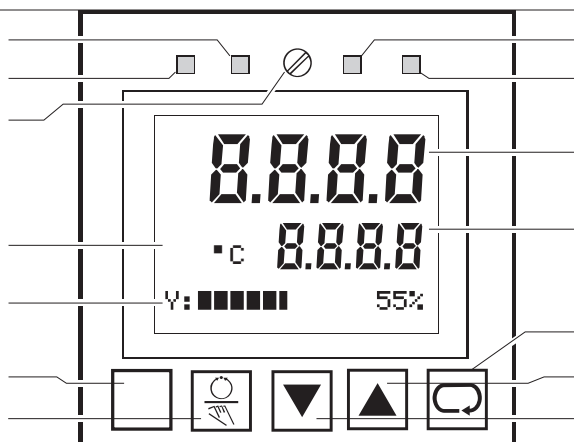

LED 3 e.g. Alarm 1
LED 4 e.g. Alarm 2

Display 1 e.g. Process value

Display 2 e.g. Set-point

Selection key
Increment key (↑)
Decrement key (↓)

Locking screw: Locks the controller module in the housing.

LEDs: indicate the status of controller outputs Y1, Y2 and alarms LIM1, LIM2 (other settings at configuration level **£.800**).

Display 1: indicates the process value at operating and parameter level, and the configuration code at configuration level.

Display 2: indicates the set-point during automatic operation at operating level and the correcting value during manual operation. The values are adjustable directly with push-buttons ▼ and ▲. Further displays can be adjusted by means of configuration code (**£.800** !).

Text 1: indicates the short-form dialogue or the unit of display 2. Further displays can be adjusted by means of configuration code (**£.800**).

Text 2: indicates the correcting variable bargraph. Further displays can be adjusted by means of configuration code (**£.800**).

PC interface: PC connection for configuration, parameter setting and operation by means of the engineering tool

4.2 Status displays



This message signals a sensor error. Possible cause:
Break or wrong polarity with thermocouple
Break or short circuit with Pt100 and potentiometric transducer
Break with 4...20mA and 2...10V standard signal

The following messages can be displayed in KS92/94 'Text1'.

| | |
|---------------|--|
| ClockF | Faulty clock (real-time clock must be re-adjusted.) |
| Recov | Recovery function is active (after power recovery, the process is controlled with the correcting variable determined last. |
| Grw | Gradient function is active (the set-point changes at an adjustable (Grw+/-) rate of change). |
| Y2 | The second correcting variable (safety correcting variable) is active |
| AdaF | Self-tuning was canceled with error. |
| Ada | Self-tuning busy |
| Timer | Timer function is active (a future starting point was not reached yet). |
| CalEr | Calibration error with automatic position feedback calibration. |
| Block | No motor actuator reaction (only with the DAC function activated). |
| DirEr | Faulty motor actuator output action (only with the DAC function activated). |
| YFail | Yp error (potentiometer defective or not connected (only with activated DAC function). |

4.3 Menus 1...3

Apart from the parameter and configuration words, the following dialogue words are used (Text1):

| Text1 | Signification |
|---------------------------|--|
| CBus CFrnt | PC communication via interface at terminals B12...B16 |
| Clear | The additional display selected at operating level is deleted (→ Mark) |
| Clock | Setting the clock |
| Conf | Transition to configuration level |
| End | Return to the previous selection menu |
| Exit | Return to operating level (main display) |
| Hold | The displayed parameter is determined as standard display. |
| Mark | The displayed parameter is stored as additional display at operating level (→ Clear) |
| More | The configuration level area described with MORE is accessible |
| OStar OStop | Self-tuning is started or stopped |
| Para | Transition to parameter level |
| PRun PStop | Programmer starting or stopping |
| PSet Pres | Programmer preset or reset |
| Quit | Return to operating level (main display) without storage of the values changed last |

4.4 The operating level

The operating level comprises main display ① and extension ②. During the main display, automatic or manual operation can be selected (☉/☒). With automatic, the set-point, and with manual, the correcting value can be adjusted directly (▲/▼). In the extension, the number and sequence of displays is dependent of selected functions. Max. 12 parameters from the parameter level can be displayed (**Mark** ↔ **Clear**). Some of these parameters are directly adjustable (▲/▼). A parameter can be displayed continuously with the **Hold** function. (Press ☐ < 3s → Select parameter (press ▲/▼) → ☐ > 3s → Select **Hold** (Press ▲/▼) → ☐). The extension can be left with **Exit** and ☐ or after a timeout of 60 s or with ☒. With ☒, the other operating mode is also selected.

☞ If the set-point is set to '----' by means of ▼, the controller is switched off!!

Menu 1 is always selectable at operating level: deletion of additional display (**Clear**), communication interface switch-over (**CBus** ↔ **CFrnt**) and starting (**OStar**) or stopping (**OStop**) the self-tuning, setting the clock (**Clock**), operate the programmer (**PRun** ↔ **PStop**; **Pres**; **PSet**) and transition to parameter level (**Para**).

Fig.: 7 Operation

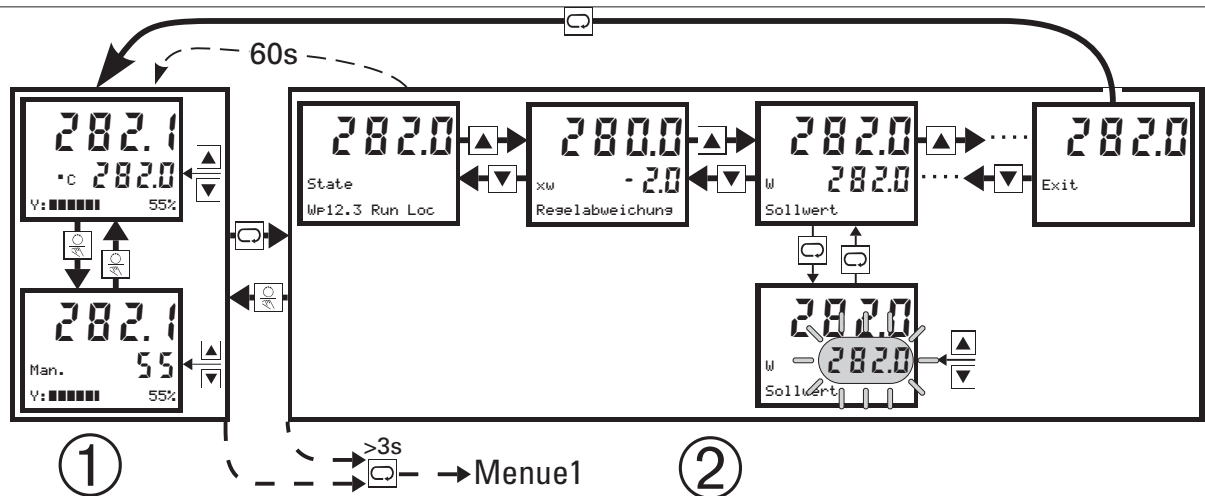

5 KS92/94 function survey

5.1 Basic hardware functions

Various KS92/94 controller versions according to order number are available. Decisive for the hardware is the number of connected circuit boards, i.e. connectors.

A large number of standard applications can be realized only with the KS92/94 basic version, which contains circuit boards P and A. The input and output functions shown in the following correspond to the basic setting. Finally, however, the individual configuration is decisive:

5.1.1 Circuit board P:

Output OUT1: positioning signal
 OUT1 can be ordered as a current or relay output.
 Dependent of selected controller type, it can be operated as a continuous 0/4...20mA signal or as a 0/20mA logic signal.

Output OUT2: positioning signal
 Output OUT4: limit signal (alarm)
 Output OUT5: limit signal (alarm)

5.1.2 Circuit board A

Universal input INP1: process variable x1 (process value)
 Difference input INP5: external set-point W_e
 Measurement input INP6: Position feedback yp with 3-point stepping and continuous controller
 Control input di1: set-point switch-over
 Control input di2: automatic/manual switch-over

5.1.3 Circuit board B (optional)

Circuit board B contains a serial interface (TTL or RS485; ISO1745- and MODBUS protocol), a real-time clock and additional control inputs and outputs, which are reserved exclusively for the programmer functions:

Control input di3: "remote/local" mode
 Control input di4: programmer start/stop
 Control input di5: programmer reset
 Control input di6: program selection
 Control input di7: program selection
 Control output do1: control output 1
 Control output do2: control output 2
 Control output do3: control output 3
 Control output do4: control output 4

5.1.4 Circuit board C (optional, only possible with KS94)

Circuit board C offers further configurable inputs and outputs.

Difference input INP3: disturbance variable z or process variable x2 (ratio, three-element, ...)
 Difference input INP4: external set-point W_e , set-point offset dW_e , override control OVC, process variable x3 (three-element), ...
 Current output OUT3: operating mode continuous 0/4...20mA or logic 0/20mA; function configurable
 Control input di8: selection control parameter set 1...4
 Control input di9: selection control parameter set 1...4
 Control input di10: override control OVC+ with three-point stepping controllers
 Control input di11: override control OVC- or set-point correction $dW(e)$ "On/off"
 Control input di12: w/W2 switch-over
 Control output do5: positioning signal y1 (switching controllers) or "A/M" status
 Control output do5: positioning signal y2 (switching controllers) or "i/e" status

5.2 Survey of included function modules

A survey of function modules and their interdependence is shown below. The individual function modules are described in the following sections.

Fig.: 11 Survey of functions

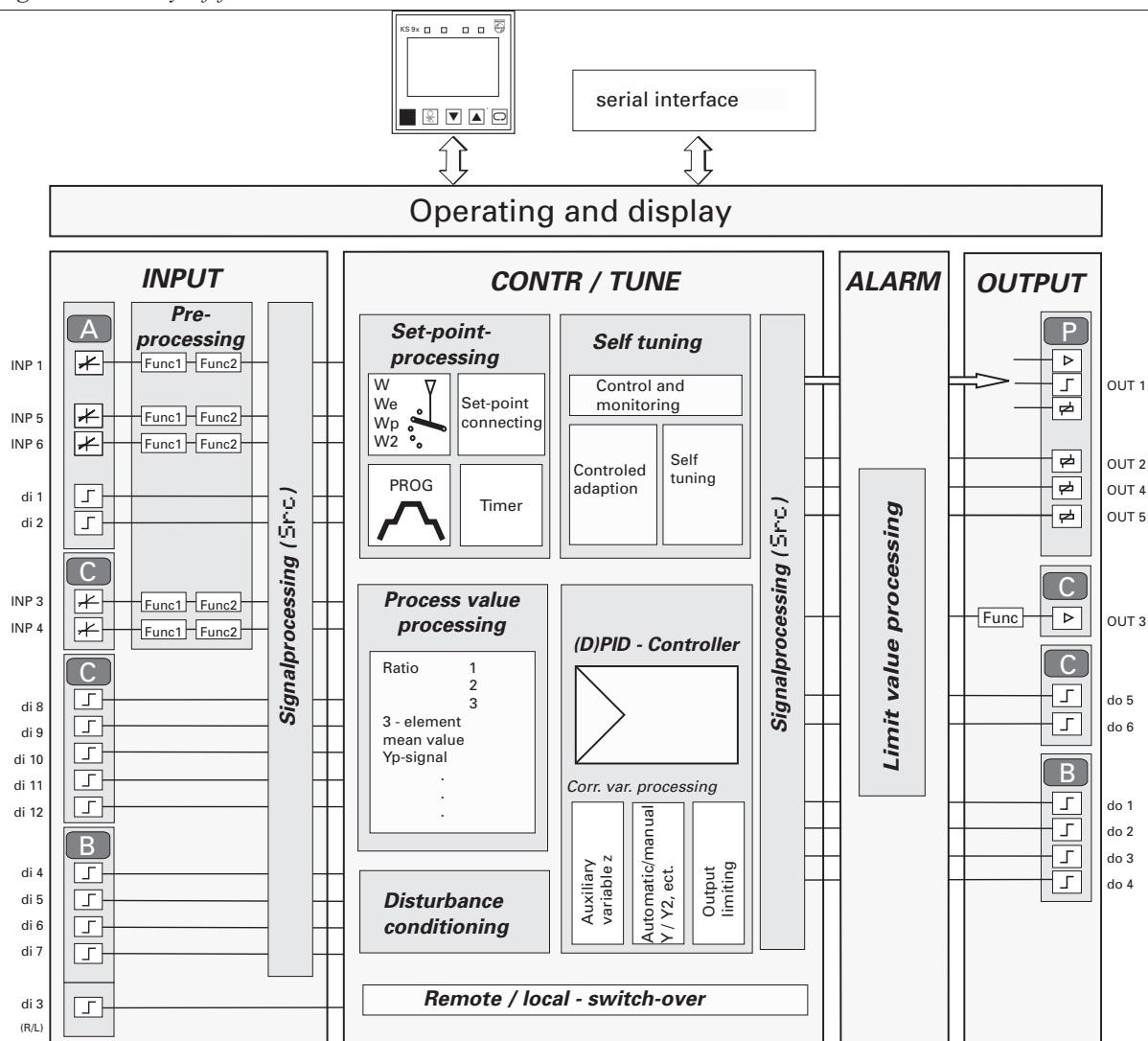

5.3 Galvanic isolation

Galvanic isolation is necessary for safety (contact safety) and for measurement reasons.

Due to the KS92/94 electronics construction, galvanic isolation is standard without extra charge.

A transformer in the power supply always isolates all inputs and outputs from the supply voltage. Data exchange between electronics p.c.b. A and power supply or output p.c.b. P is also galvanically isolated. I.e. positioning output **OUT1** which can be designed for 0/4...20 mA, is also isolated from all inputs.

Control inputs **di**, control outputs **do** and serial interface are always galvanically isolated via opto-couplers, i.e. they cannot contribute to stray potential and error due to leakage current.

Although additional current inputs INP3 and INP4 of option C are galvanically connected (difference inputs; COMMON), they are isolated from the rest of the instrument. This also applies to current output OUT3.

This means: if hardware option C is used, process value, set-point and correcting variable can be galvanically isolated. Even an additional process value output OUT3 (0/4...20mA) is galvanically isolated from the input.

Common control signals as A/M, w/W2, int/ext, etc., e.g. signals coming from a PLC and in many cases without galvanic isolation, are handled with galvanic isolation and do not cause potential compensation. The same applies to control outputs **do**, which are connected electrically with control units, i.e. which imply a risk of potential connections.

In the connecting diagram on page 13, the double lines clearly show the galvanic isolations throughout the controller.

Galvanic isolation of inputs and outputs is shown in the following drawing.

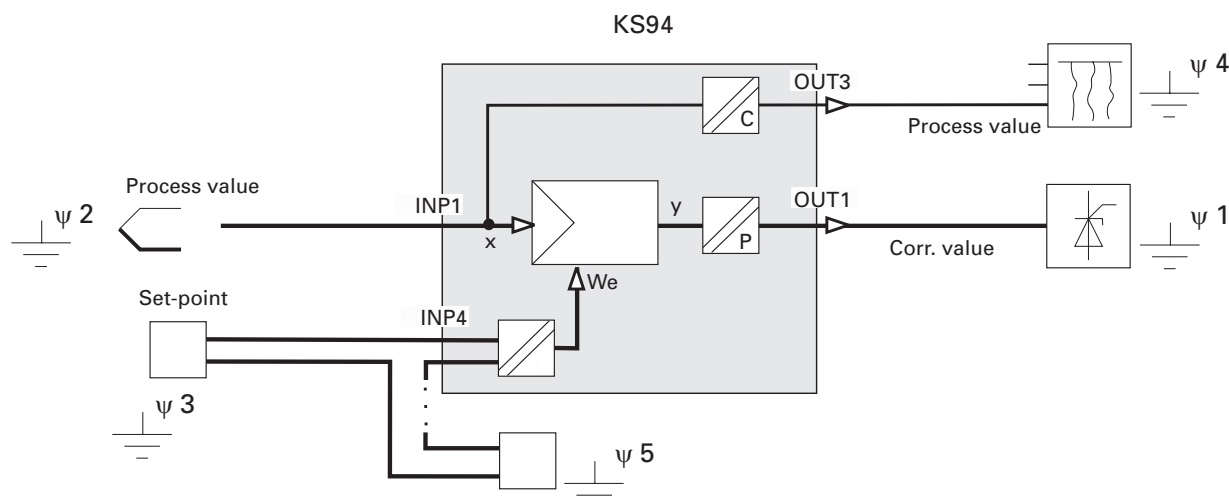

5.4 Input conditioning

Before the pre-filtered (time constant ...; limiting frequency ...) analog input signals are available as digitized measurement values with physical unit and can be used e.g. as process value, set-point or position feedback, they undergo extensive conditioning.

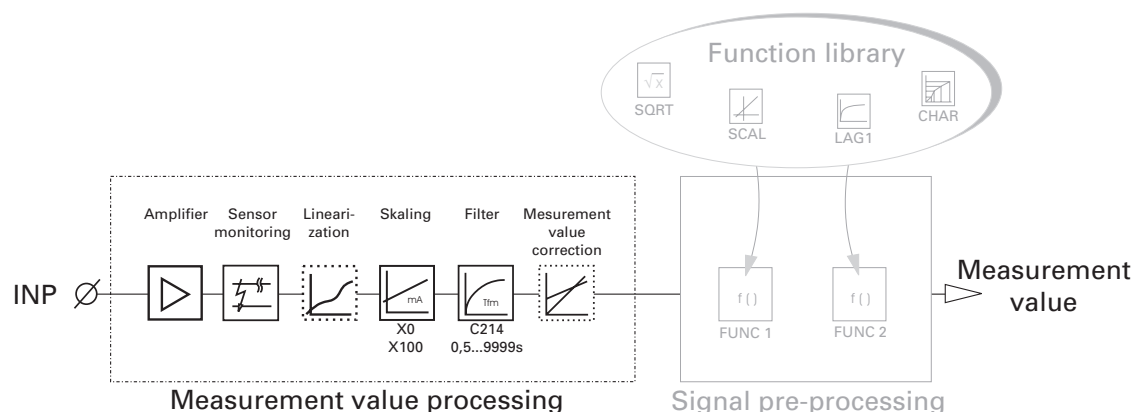

5.4.1 Input circuit monitor

Thermocouples

The input circuit monitor provides thermocouple checking for break and wrong polarity. An error is found, if the value of the measured thermovoltage is by more than 30 K below the span start.

Pt100 measurements and potentiometric transducers are monitored for break and short circuit.

Current and voltage signals

With current (0/4...20 mA) and voltage signals (0/2...10V), monitoring for exceeded range ($I > 21,5$ mA or $U > 10,75$ V) and for short circuit ($I < 2$ mA or $U < 1$ V) with “life zero” signals is provided.

Sensor errors can be output as control signal. In case of error, upscale or downscale action of the input circuits are possible.

i Moreover, a “substitute” value can be defined with controller KS94.

Unless the main correcting variable, but e.g. external set-point, set-point offset or external output limiting are concerned, control can be continued also with failure of an auxiliary variable.

After removal of a sensor error, the controller waits, until the input signal has settled (approx. 10s), before the controller is initialized (outputs switched off during several seconds).

5.4.2 Scaling

Standard signals mA and V are scaled according to the physical measuring range of the transformer (x0, x100).

With potentiometric transducer measurements (INP1, INP6), “calibration” is according to a well-proven, practice-oriented method. Bring the transducer to span start and then to span end position and “calibrate” it for 0% or for 100% by pressing a key at parameter level. Calibration is basically a scaling procedure, whereby gradient and zero correction are calculated automatically via the firmware.

5.4.3 Linearization

Generally, thermocouples and Pt100 are measured in the overall physical measuring range according to data sheet, and linearized according to the relevant allocation table. Linearization is realized by error curve approximation with up to 28 segment points.

5.4.4 Additional measurements

Dependent of configured sensor type, additional and corrective measurements are required.

The amplifier zero is checked with all measurement types and taken into account during measurement value calculation. The lead resistances with Pt100 and potentiometric transducer, and the cold-junction reference temperature (internal TC) with thermocouples are measured additionally.

5.4.5 Filter

In addition to filtering in the analog section of each input signal, a 1st order filter is adjustable (filter time constant 0,5...9999s; configuration).

5.4.6 Scanning intervals

The internal scanning interval of controllers KS92 and KS94 is 100ms.

A survey of input and output scanning intervals, front LEDs, operating keys and serial interfaces is given in the following table.

| Description | Scanning interval | Circuit board |
|---|-------------------|---------------|
| Serial interfaces | 100 ms | B, front |
| LEDs | 100 ms | front |
| Keys | 100 ms | front |
| INP1 | 200 ms | A |
| TC, with thermocouples | 2,4 s | A |
| Compensation measurement of the lead resistance with Pt100 and transducer | 2,4 s | A |
| Zero correction using an internal reference voltage | 2,4 s | A |
| INP3 | 200 ms | C |
| INP4 | 200 ms | C |
| INP5 | 800 ms | A |
| INP6 | 400 ms | A |
| OUT 1,2,4,5 | 100 ms | P |
| OUT3 | 100 ms | C |
| di3...7 | 100 ms | B |
| di8...12 | 100 ms | C |
| do1...4 | 100 ms | B |
| do5,6 | 100 ms | C |

5.4.7 Linearization error

Thermocouples and Pt100 are linearized within nearly the overall physical measuring range. Linearization is with up to 28 segments, which are placed in the error curve optimally to compensate the linearity errors. As the error curve approximation is only by polygons and not by an nth order polynomial, the remaining error is zero in some points of the characteristic curve. Between these “zero points”, however, there is a very low, though measurable remaining error. For reproducibility, however, this error is not relevant, because it would be reproduced in exactly the same point, if the measurement would be repeated under identical conditions.

5.4.8 Temperature compensation

Measurement of the cold-junction reference temperature with thermocouples is using a PTC resistor. The temperature error thus determined is converted into mV of the relevant thermocouple type, linearized and added to the measurement value as correcting value with correct polarity. The remaining error with varying cold-junction reference temperature is approx. 0,5K/10K, i.e. about one twentieth of the error which would occur without compensation. Better results are possible with a controlled, external TC, which is adjustable within -99...+100°C dependent of temperature adjusted at the cold-junction reference.

With comparative measurements for assessment of the “reproducibility”, however, constant environmental conditions are indispensable when working with internal TC! A draft at the PTC resistor of the cold-junction reference can be sufficient to produce a measurement error.

5.4.9 Measurement value correction (optional)

The measurement value correction can be used for correcting the measurement.

Prerequisite: Configuration word `L205;KKorr = 1` (→ page 104)

In most case, the relative accuracy and reproducibility rather than the absolute one is of interest, e.g.

- measurement error compensation in a working point (set-point control)
- minimization of linearity errors in a limited working range (variable set-point)
- conformity with other measuring equipment (recorders, indicators, PLCs, ...)
- compensation of the sensor, transmitter, etc. stray errors

The optional measurement value correction can be designed both for zero correction and gain matching. It corresponds to a scaling $mx+b$, with the difference that the controller firmware calculates the gain m and the zero offset b from the pre-defined values for process value (x_{1in} ; x_{2in}) and set-point (x_{1out} ; x_{2out}) of two reference points.

Example 1:

Zero offset

$$\begin{aligned} x_{1in} &= 100^{\circ}\text{C} & x_{1out} &= 100^{\circ}\text{C} + 1,5^{\circ}\text{C} \\ x_{2in} &= 300^{\circ}\text{C} & x_{2out} &= 300^{\circ}\text{C} + 1,5^{\circ}\text{C} \end{aligned}$$

The difference between corrected values and input values is equal over the complete range.

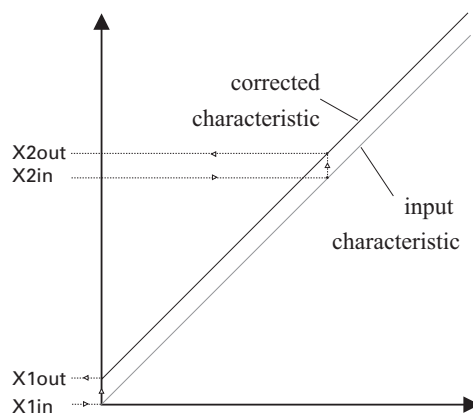

Example 2:

Gain change (rotated around the coordinate origin)

$$\begin{aligned} x_{1in} &= 0^{\circ}\text{C} & x_{1out} &= 0^{\circ}\text{C} \\ x_{2in} &= 300^{\circ}\text{C} & x_{2out} &= 300^{\circ}\text{C} + 1,5^{\circ}\text{C} \end{aligned}$$

The corrected values are equal to the input values at x_{1in} and x_{1out} , but the difference increases.

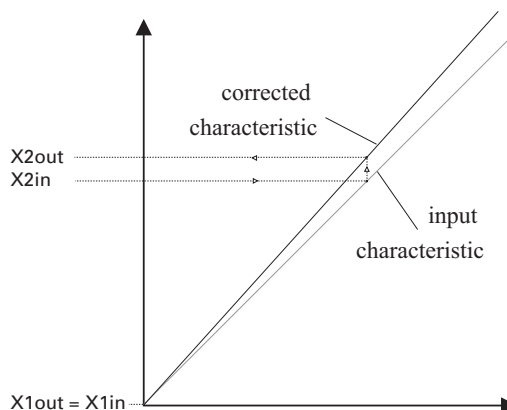

Example 3:

Zero and gain matching

$$\begin{aligned} x_{1in} &= 100^{\circ}\text{C} & x_{1out} &= 100^{\circ}\text{C} - 2,0^{\circ}\text{C} \\ x_{2in} &= 300^{\circ}\text{C} & x_{2out} &= 300^{\circ}\text{C} + 1,5^{\circ}\text{C} \end{aligned}$$

The corrected values are already different at input values x_{1in} and x_{1out} and the difference increases additionally.

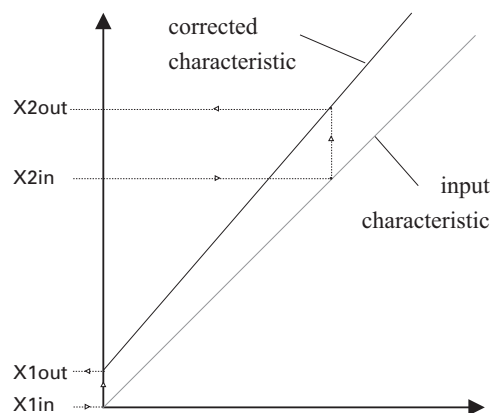

5.5 Signal pre-processing

Input value conditioning is followed by signal pre-processing.

The analog input signals can undergo further conditioning.

Func1 and **Func2** are spacekeepers for configurable functions which can be selected from the following function library:

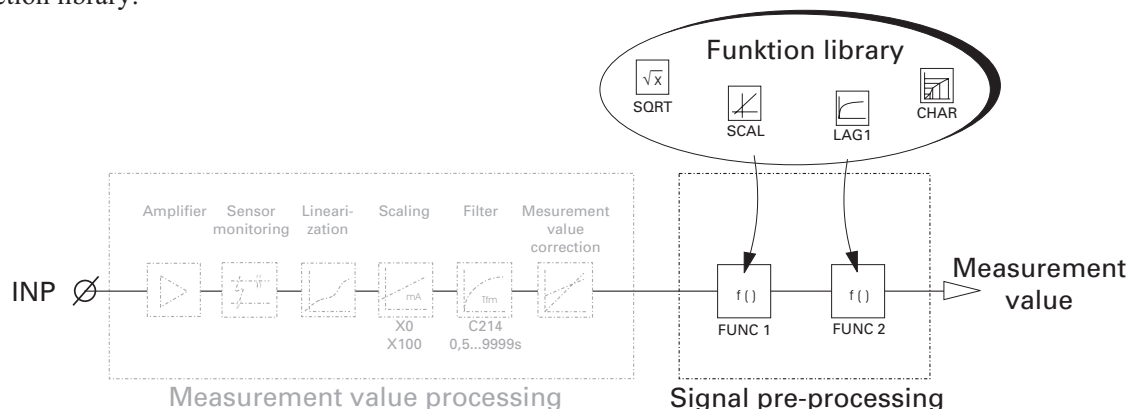

Each function can be used only once (either in Func1 or in Func2). The table gives a survey of inputs and usable functions.

| Function | INP1 (C. 220) | INP3 (C. 320) | INP4 (C. 370) | INP5 (C. 420) | INP6 (C. 470) |
|----------|------------------|------------------|------------------|------------------|------------------|
| SCAL | X | only with KS94 | only with KS94 | X | X |
| CHAR | X | — | only with KS94 | — | — |
| SQRT | X | only with KS94 | only with KS94 | X | X |
| LAG1 | X | only with KS94 | only with KS94 | X | X |

SCAL - Scaling
Scaling is done according to equation
 $OUT = m \cdot INP + b$.
Hereby, parameters m and b can be adjusted so that inverse characteristics can also be realized.
Adjustable parameters: m = gain and b = offset

CHAR - Linearization
Up to 8 adjustable segment points (value pairs x_{si}/y_{si}) can be used to simulate or linearize non-linear functions. The number of value pairs is limited to 8 (7 segments). If less than 8 value pairs are used, the first unused segment must be switched off by entry of the x_s -value into "—". Offset and gradient for the relevant intervals are determined automatically from the adjusted value pairs. The segment points are interconnected by straight lines, so that there is a defined output value (y_s) for each input value (x_s). Beyond the defined intervals, the first or last segment is prolonged. Adjustable parameters: for each input - (x_1, y_1), (x_2, y_2)...(x_8, y_8)
Note that the input values (x -values) must be entered in ascending order.

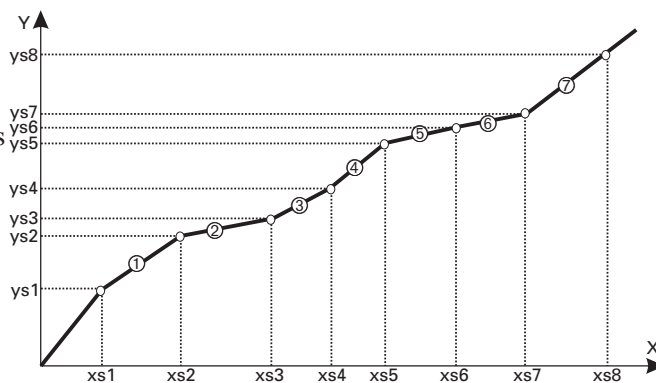

SQRT- Square root
The square root of the input signal is calculated and the result is multiplied by parameter "gain".
 $OUT = gain * \sqrt{INP}$
If the value under the root is negative, the result is set to 0.
Adjustable parameter: for each input - gain

- LAG1 Filter
The input value is taken to the output with delay. The delay is according to a 1st order e-function (1st order low pass) with the filter time adjustable with parameter Tf.
Adjustable parameter: Tf = filter time

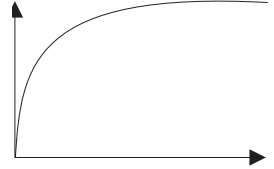

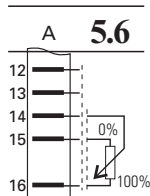

5.6 Inputs

The input names and numbers were selected for utmost language-independent, international clarity of the inputs and outputs on the process value display (7 segments) during configuration. Digital inputs and output are marked with lower case letters to permit clear distinction of "0" and "o" on the display.

INPUT: - analog inputs

The signal inputs for the previously selected controller configuration are determined in this main group. The signal inputs for the selected controller function are displayed in the configuration menu. As with control function configuration, a large number of applications can be covered by determination of the main configuration. Special cases can be matched and adjusted by additional option configuration at the second level. INP2 is not available with controllers KS92/42. Therefore, there is a gap in the input sequence. Max. the following five signal inputs are available:

- process value x: INP1, INP3 or INP4
- external set-point W_e , dW_e : INP5
- position feedback y_p : INP6

5.6.1 Signal input 1 INP1 (main variable x_1) (→ $\underline{\underline{200}}$)

The analog input INP1 is used as main variable x_1 .

The input sensor type can be determined as thermocouple, resistance thermometer, potentiometric transducer or as a standard signal. The physical unit is freely selectable. If required, additional input configurations can be determined with the extra configuration.

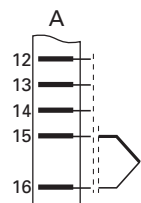

Thermocouple input

The following thermocouple types are configurable as standard:

Type **E, J, K, L, N, R, S, T** and **W** to IEC584.

The signal behaviour can be affected by configuration of the following points. Distinction of internal and external temperature compensation is made (→ $\underline{\underline{205}}$).

- Internal temperature compensation:
The compensating lead must be taken up to the controller terminals. Lead resistance adjustment is not required.
- External temperature compensation:
A separate cold-junction reference with a fixed reference temperature must be used (configurable between 0 and 100°C) (→ $\underline{\underline{210}}$)
The compensating lead must be taken only up to the cold-junction reference, from which point copper lead must be used. Lead resistance adjustment is not necessary.
- Upscale (set-point \ll process value) or downscale (set-point \gg process value) action of the built-in TC monitoring can be configured, or a fixed substitute value can be used for the action. (→ $\underline{\underline{205}}$).
- For input value processing, a filter time constant with a numeric value between 0,5 and 999,9 is adjustable (→ $\underline{\underline{214}}$).
- A process value correction is configurable (→ $\underline{\underline{205}}$).

The order of configuration is as follows:

$\underline{\underline{200}}$ → $\underline{\underline{205}}$ - ($\underline{\underline{210}}$) - ($\underline{\underline{214}}$)

Resistance thermometer input

Resistance thermometer, temperature difference

With a resistance thermometer, the signal behaviour with sensor break can be determined (→ 2.205). Temperature compensation is not required and therefore switched off. With temperature difference measurement, calibration by means of short-circuit is required.

Lead resistance adjustment can be done using e.g. the 10 calibrating resistor (order no. 9404 209 10101). Dependent of sensor type, the controller must be configured for one of the following inputs:

- resistance thermometer Pt 100 with linearization
- temperature difference with 2 x Pt 100 and linearization
- linear potentiometric transducers

For input value processing, a filter time constant with a numeric value within 0,5 and 999,9 is adjustable (→ 2.214). The decimal point (digits behind the decimal point) and process value correction can be configured (→ 2.205).

Configuration is in the following order:

2.200 → 2.205 - (2.214) - (2.215)

Resistance thermometer Pt 100

The two ranges -99,9...+250,0 °C and -99,9...+850,0 °C are configurable (→ 2.205).

Connection is possible in two or three-wire circuit. Measuring leads must be of copper. The input circuit monitor responds with -130°C (sensor break or lead break). The output action is configurable for:

- upscale (set-point << process value) (→ 2.205)
- downscale (set-point >> process value) (→ 2.205)
- a fixed value (in case of error, the selected number is used for the value to be measured (→ 2.213)).

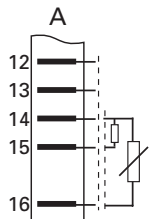

Resistance thermometer in 2-wire connection:

For lead resistance adjustment, disconnect the measuring leads from the controller and short-circuit them in the connecting head of the resistance thermometer. Now, measure the resistance of the measuring lead using a resistance bridge and connect a calibrating resistor (R_a) of the same value.

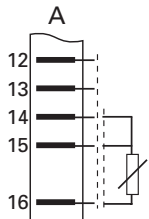
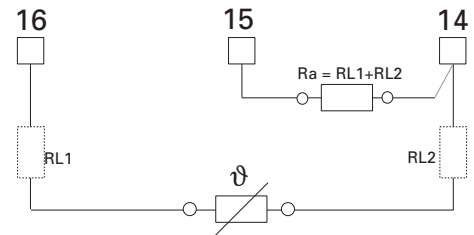

Resistance thermometer in 3-wire connection:

The resistance of each input lead must not exceed 30 Ω. Lead resistance adjustment is not necessary, provided that the resistances R_a of the input leads are equal. If necessary, they must be equalized using a calibrating resistor.

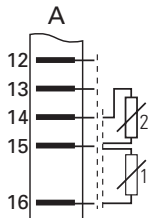
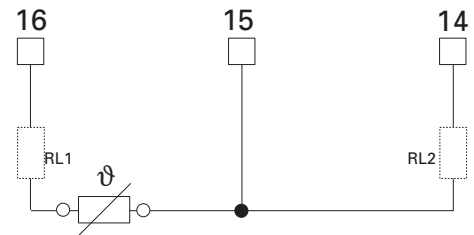

Temperature difference 2 x Pt100

Range $\vartheta_1 - \vartheta_2$ is within -200,0...+300,0 °C ($\vartheta_2 =$ referene). For lead resistance adjustment for INP1, take the controller into manual operation and select calibrating parameter x_{off} as shown in Fig.:12. Press the selector key to prepare the calibration ("C" in the display x_{off} flashes). Now, short circuit the input leads at the two PT100 resistors. Press the selector key again to store the measured resistance value as lead resistance, in order to correct the subsequent measurements accordingly. Remove the short circuits of the leads.

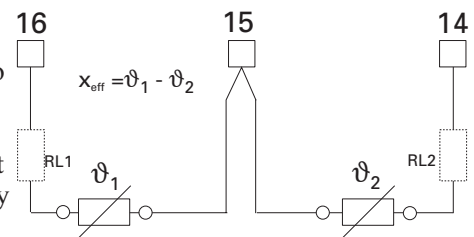

□ Potentiometric transducer

The overall resistance $\leq 500 \Omega$ incl. $2 \cdot RL$.

Calibration or scaling are done with the sensor connected.

An input circuit monitor can be configured for sensor or lead break or short circuit. The action, process value correction and decimal point are adjustable (→ [C.205](#) and [C.213](#)).

Configuration is in the following order:

[C.200](#) → [C.205](#) - [C.211](#) - [C.212](#) - [C.214](#)

Calibration for X_0 and X_{100} is at parameter level as follows.

Calibration is only possible with the controller set to manual mode.

Potentiometric transducer calibration for X_0 or X_{100} is possible via the interface and the front foil.

Calibration is in two steps:

Fig.: 12 Selecting parameter $\times 0c$ / $\times 100c$

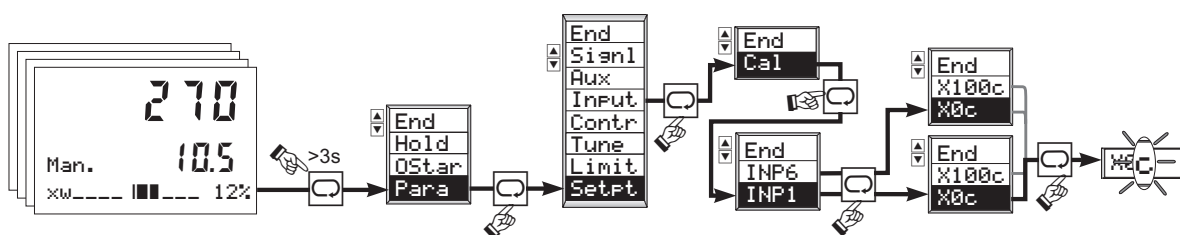

- Calibration for X_0 :
Select $\times 0c$ as shown in Fig.: 12. Press the selector key, the “c” on the display $\times 0c$ starts blinking. Now, bring the potentiometric transducer into the position for X_0 (usually lower end position). The instantaneously valid value for INP1 appears on display 1. Press the selector key again to store this actual value as X_0 .
- Calibration for X_{100} must be done accordingly.
Select $\times 100c$. Press the selector key. The “c” of the display $\times 100c$ starts blinking. Now, bring the transducer into the position for X_{100} (usually upper end position). The instantaneously valid value for INP1 is shown on display 1. Press the selector key again to store this actual value as X_{100} .

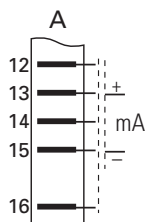

□ Standard 0/4...20 mA signal input

The input resistance is 50Ω

During configuration, distinction of 0...20 mA and 4...20 mA is made. For the 4 ... 20 mA standard signal, the behaviour with sensor break can be determined ([C.213](#)). Moreover, the decimal point and thus the digits behind the decimal point are configurable (→ [C.200](#)). Additionally, a physical input signal scaling by means of X_0 and X_{100} is possible (→ [C.201](#) and [C.202](#)). For input value processing, a filter time constant with a numeric value within 0,5 and 999,9 is adjustable (→ [C.214](#))

For configuration, proceed in the following order:

[C.200](#) → [C.201](#) - [C.202](#) - [C.205](#) - [C.213](#) - [C.214](#)

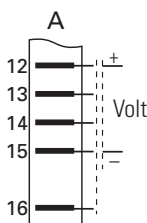

□ 0/2...10 V input

The input resistance is $\geq 100 k\Omega$

During configuration, distinction of 0...10 V and 2...10 V is made. For the 2 ... 10 V standard signal, the output action with sensor break can be determined ([C.213](#)). Moreover, the decimal point and thus the digits behind the decimal point are adjustable (→ [C.200](#)). Additionally, a physical input signal scaling by means of X_0 and X_{100} is possible (→ [C.201](#) and [C.202](#)). For input value processing, a filter time constant with a numeric value within 0,5 and 999,9 can be used (→ [C.214](#)).

For configuration, proceed in the following order:

[C.200](#) → [C.201](#) - [C.202](#) - [C.205](#) - [C.213](#) - ([C.214](#))

5.6.2 Additional signal input 3 / INP3 (optional) (→C.300)

This signal input is only available with option p.c.b. "C" fitted.

It may be configured for ratio variable x_2 or disturbance variable z (→C.105 or C.180).

Selection of standard input signals 0...20 mA and 4...20 mA is possible. The physical unit can be configured. The input resistance is 50 Ω . For the 4...20 mA standard signal, the output action with sensor break can be configured (→C.305 and C.313).

Physical input scaling is possible by determination of 0 % and 100 % (→C.301 and C.302). Moreover, the decimal point, i.e. the digits behind the decimal point can be configured (→C.300).

For input value processing, a filter time constant with a numeric value within 0,5 and 999,9 is adjustable (→C.314)

For configuration, proceed in the following order:

C.300 → C.301 - C.302 - C.305 - C.313 - (C.313)

5.6.3 Additional signal input 4 / INP4 (optional) (→C.350)

This signal input is only available with option p.c.b. "C" fitted.

It can be configured for three-element control x_3 , external set-point or external set-point offset (→C.180).

Selection of 0...20 mA and 4...20 mA standard input signals is possible. The physical unit can be configured. The input resistance is 50 Ω . For the 4...20 mA standard signal, the output action with sensor break can be determined (→C.355 and C.363).

A physical input scaling is possible by determination of 0 % and 100 % (→C.351 and C.352). Moreover, the decimal point, i.e. the digits behind the decimal point can be configured (→C.350).

For input value processing, a filter time constant with a numeric value within 0,5 and 999,9 can be adjusted (→C.364).

For configuration, proceed in the following order:

C.350 → C.351 - C.352 - C.355 - C.363 - (C.364)

5.6.4 Signal input 5 / INP5 (ratio variable x_2 , ext. set-point W_{ext}) (→C.400)

Analog input INP5 is used for connection of the signal for ratio variable x_2 or for the external set-point W_{ext} , if option p.c.b. is not fitted in the controller and with the function selected during controller configuration. Selection of 0/4...20 mA and 0/2...10 V signals is possible. The physical unit can be configured.



This input is a difference input. Terminal A9 is used as reference potential (Common). With voltage signals, terminal A6 must always be connected with terminal A9.

The input resistance is 50 Ω as mA input and ≥ 100 k Ω as V input.

For the 2 ... 10 V or 4...20 mA standard signals, the output action with sensor break can be determined (→C.405 and C.413). Moreover, the decimal point, i.e. the digits behind the decimal point can be selected (C.400). Additionally, a physical input scaling by determination of 0 % and 100 % is possible (→C.401 and C.402).

For input value processing, a filter time constant with a numeric value within 0,5 and 999,9 can be adjusted (→C.414)

Configuration is in the following order:

C.400 → C.401 - C.402 - C.405 - C.413 - (C.414)

See also external set-point W_{ext} page 45 and ratio controller page 49

5.6.5 Signal input 6 / INP6 (auxiliary variable yp, position feedback yp) (→ [£.450](#))

The signal for auxiliary variable yp or position feedback is configured at analog input INP6, if this was selected during controller configuration.

For this input, the decimal point and thus the digits behind the decimal point can be selected (→ [£.450](#)) Moreover, a physical input signal scaling by determination of 0% and 100 % is possible (→ [£.451](#) and [£.452](#)).

The output action with sensor break can be selected only with 4...20 mA standard signal (→ [£.455](#) and [£.463](#)).

For input value processing, a filter time constant with a numeric value within 0,5 and 999,9 can be adjusted (→ [£.464](#)).

Configuration is in the following order:

[£.450](#) → [£.451](#) - [£.452](#) - [£.455](#) - [£.463](#) - [£.464](#)

See also position feedback yp page 56

5.6.6 Digital inputs “di”

Energization of digital inputs “di” via an external 24 V DC supply is required. The current consumption for each input is 5 mA.

The digital inputs can be energized by one or several voltage sources (e.g. 24V PLC control outputs). Note that the negative potentials of the voltage sources are identical and must be taken to the corresponding controller connecting terminals.

Connecting examples:

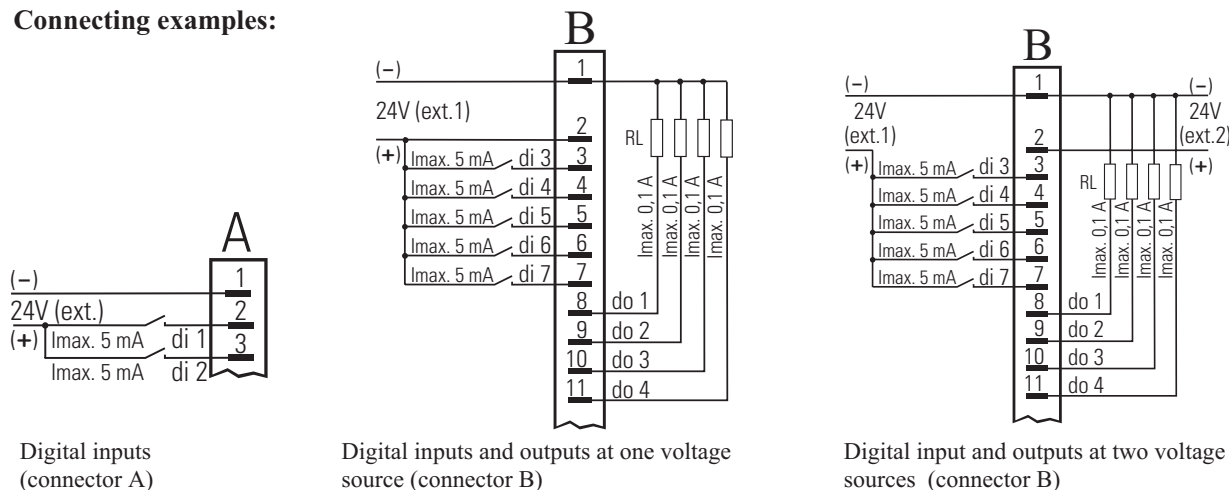

Digital inputs
(connector A)

Digital inputs and outputs at one voltage
source (connector B)

Digital input and outputs at two voltage
sources (connector B)

Digital inputs di1 and di2

Dependent of configuration ([£.190](#) and [£.191](#)), digital inputs d1 and d2 can control the following operations. Allocating several functions to a digital input is also possible.

- Switch-over between internal set-point W (0) and second set-point W2 (1)
- Switch-over between automatic (0) and manual (1) mode
- Set-point offset switch-on; normal (0) offset (1)
- Switch-over between normal correcting value (0) and safe correcting value (1)
- Switches the controller ON (0) or OFF (1)
- Switch-over between PI (0) and P (1) with 2/3-point and continuous controllers or feedback switch-off with 3-point stepping controllers
- Bumpless switch-over between normal correcting value (0) and safe correcting value (1)
- Bumpless switch-over to the internal set-point (tracking only di2) OFF (0) ON (1)

Digital inputs di3 to di12

- di3 used for switch-over between local (0) and remote (1).
- di4 used for switch-over between program STOP (0) and START (1) ($\mathcal{L}.192$; $SPrSt$).
- di5 used for programmer RESET; normal (0), reset (1).
- di6/di7 used for program number selection with programmer.



| | | | |
|---------|---|---|---|
| di6 | 0 | 1 | x |
| di7 | 0 | 0 | 1 |
| Program | 1 | 2 | 3 |



| | | | | |
|---------------|---|---|---|---|
| di8 | 0 | 1 | 0 | 1 |
| di9 | 0 | 0 | 1 | 1 |
| Parameter set | 0 | 1 | 2 | 3 |

- di7/di8 used for program number selection with programmer.
- di10 minimum delimitation of the correcting variable with 3-pnt.stepping controller
- di11 maximum delimitation of the correcting variable with 3-pnt.stepping controller and can be configured for switching on the effective set-point offset ($\mathcal{L}.190$; $SdWOn$).
- di12 switches over bumplessly to the internal set-point (tracking) OFF (0) ON (1). and can be used for switching over to the second set-point W2 ($\mathcal{L}.190$) OFF (0) ON (1).

5.7 Outputs

The input names and numbers were selected for utmost language-independent, international clarity of the inputs and outputs on the process value display (7 segments) during configuration. Digital inputs and output are marked with lower case letters to permit clear distinction of "0" and "o" on the display.

OUT: outputs

Dependent of hardware, there may be four switching outputs or three switching and one analog output. Additionally, there may be optional output OUT3, which is located on plug-in options p.c.b. "C". OUT1 can be ordered as switching or continuous output. Outputs OUT2, OUT4 and OUT5 are always switching and output OUT3 is always analog.



Behaviour of outputs with initialisation
All outputs are switched off for 100 ms at the end of initialisation. Analog outputs take over the lower output value (0/4 mA).

5.7.1 Signal output 1 OUT1 (→ $\mathcal{L}.500$)

Signal output OUT1 is used for controller correcting variable Y1/Y2. As it is a universal output, extensive functions can be configured.

Which signal shall be taken to this output must be determined at configuration word $\mathcal{L}.500$; Src :

- 00: none (output switched off)
- 01: controller output Y1/Yout1
- 02: controller output Y2/Yout2
- 03: controller output Ypid
- 04: position feedback Yp
- 05: control deviation xw
- 10: process value xeff
- 11: process value x1
- 12: process value x2
- 13: process value x3
- 20: Wint
- 21: Wext
- 22: dWext
- 23: Weff
- 24: Wp (programmer)
- 25: Alarm 1 (Limit 1)
- 26: Alarm 2 (Limit 2)
- 27: Alarm 3 (Limit 3)
- 28: Alarm 4 (Limit 4)

With a controller with continuous output, the output signal type can also be determined. 0...20 mA, 4...20 mA or logic signal 0 and 20 mA can be selected.

Direct or inverse motor actuator output action can be adjusted.

5.7.2 Signal output 2 OUT2 (→ $\mathcal{L}.530$)

Switching signal output OUT2 is used for controller correcting variable Y1/Y2. This is a relay output.

Which signal should be taken to this output must be determined at configuration level. Selection of controller output Y1/2 and alarm signals (limit) is possible.

Direct or inverse motor actuator output action.

5.7.3 Additional signal output 3 OUT3 (optional) (→ 5.550)

This output is only provided in conjunction with options p.c.b. "C".

Analog signal output OUT3 is used for a selectable controller signal. As this is a universal output, it can be configured for extensive functions.

Which signal shall be taken to this output must be determined at configuration level (5.550). Selection between various controller outputs, process values and set-points is possible. Direct or inverse motor actuator action is selectable. The output signal type can be determined. Selectable are 0...20 mA, 4...20 mA or logic signal 0 and 20 mA.

Before the signals reach output OUT3, they can be processed again by means of function block "Func" (→ 5.555). Configuration parameter Func permits selection of direct signal output, scaling and linearization.



With direct signal output, the subsequently adjustable parameters X_0 and X_{100} are not taken into account (5.570 and 5.571)

Scaling

Scaling is adjustable according to reference values X_0 and X_{100}

Example 1:

This scaling is a simple allocation of 0...100 to 0...20 mA.

The output is determined for 0...20 mA.

$X_0 = 0 \quad X_{100} = 100$

When applying value 50, the output is 10 mA.

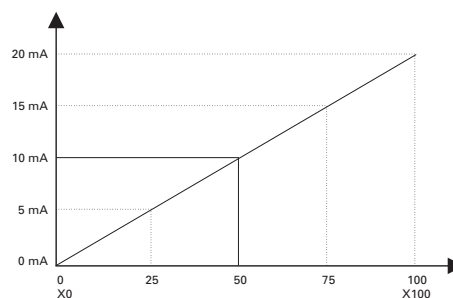

Example 2:

This scaling is an allocation of 0...200 to 0...20 mA.

The output is determined for 0...20 mA.

$X_0 = 0 \quad X_{100} = 200$

When applying value 50, the output is 5 mA.

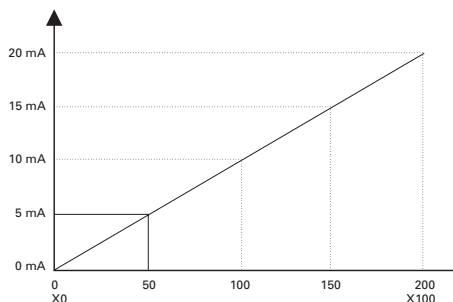

Example 3:

This scaling is an allocation of 10...110 to 0...20 mA, whereby an offset is provided.

The output is determined for 0...20 mA.

$X_0 = 10 \quad X_{100} = 110$

When applying value 50, the output is 8 mA.

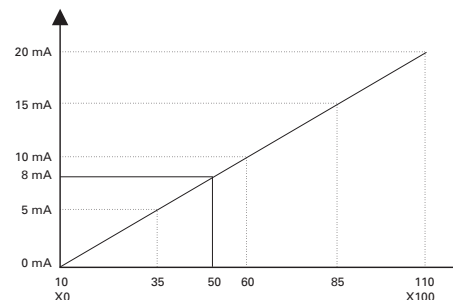

CHAR - Linearization

8 adjustable segment points (value pairs x_{si}/y_{si}) can be used for simulation or linearization of non-linear functions.

The number of value pairs is limited to 8 (7 segments). When using less than 8 value pairs, the first unused segment must be switched off by entry of the x_s value into " - - - -".

Offset and gradient for the relevant intervals are calculated automatically from the adjusted value pairs.

The segment points are interconnected by straight lines so that each input value (x_s) corresponds to a defined output value (y_s).

Beyond the defined segments the first or the last segment is prolonged. Adjustable parameters: $(x_1, y_1), (x_2, y_2) \dots (x_8, y_8)$

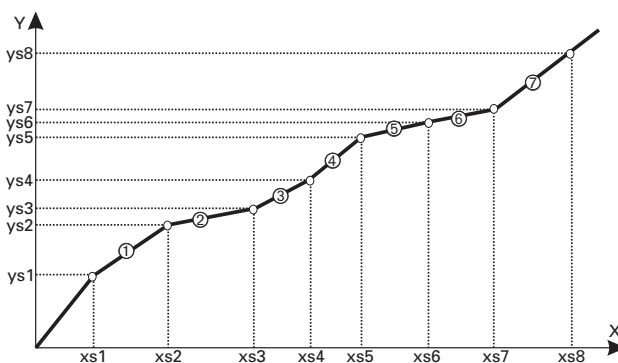

Input values (x-values) have to be set in ascending order.

5.7.4 Signal output 4 OUT4 (→ 5.90)

Switching signal output OUT4 can be used for various signals. This is a relay output. Which signal shall be taken to this output must be determined at configuration level. Selection of controller output Y1/2 and alarm signals (limit) is possible. One of the four programmer outputs 1...4 and programmer end is possible. Direct or inverse motor actuator output action can be adjusted.

5.7.5 Signal output 5 OUT5 (→ 5.91)

Switching signal output OUT5 can be used for various signals. This is a relay output. Which signal shall be taken to this output must be determined at configuration level. Selection of controller output Y1/2 and alarm signals (limit) is possible. One of the four programmer outputs 1...4 and programmer end is possible. Direct or inverse motor actuator output action can be adjusted.

5.7.6 Digital outputs do1 to do6

- do1 indicates the status of control output 1 with programmer.
- do2 indicates the status of control output 2 with programmer.
- do3 indicates the status of control output 3 with programmer.
- do4 indicates the status of control output 4 with programmer.
- do5 indicates, if the controller is in manual or automatic mode, or the y1 condition with switching controllers (5.95).
- do6 indicates, if the controller uses the external or the internal set-point, or status y2 with switching controllers (5.97).

5.7.7 Input and output survey

allocation of analog inputs / outputs and circuit boards

| process inputs | circuit board | | process outputs | circuit board | |
|----------------|---------------|------------|-----------------|---------------|------------|
| | A | C (option) | | P | C (option) |
| INP1 | X | | OUT1 | X | |
| INP3 | | X | OUT2 | X | |
| INP4 | | X | OUT3 | | X |
| INP5 | X | | OUT4 | X | |
| INP6 | X | | OUT5 | X | |

allocation of digital inputs / outputs and circuit boards

| control inputs | circuit board | | | control outputs | circuit board | |
|----------------|---------------|------------|------------|-----------------|---------------|------------|
| | A | B (option) | C (option) | | B (option) | C (option) |
| di1 | X | | | do1 | X | |
| di2 | X | | | do2 | X | |
| di3 | | X | | do3 | X | |
| di4 | | X | | do4 | X | |
| di5 | | X | | do5 | | X |
| di6 | | X | | do6 | | X |
| di7 | | X | | | | |
| di8 | | | X | | | |
| di9 | | | X | | | |
| di10 | | | X | | | |
| di11 | | | X | | | |
| di12 | | | X | | | |

Function allocation of analog inputs

| | X1 | X2 | X3 | Ext. set-point | Ext. set-point offset | Auxiliary variable z | Position feedback | OVC | Min/Max selection |
|------|----|----|----|----------------|-----------------------|----------------------|-------------------|-----|-------------------|
| INP1 | X | | | | | | | | |
| INP3 | | X | | | | X | | | X |
| INP4 | | | X | X | X | X | | X | |
| INP5 | | X | | X | X | | | | |
| INP6 | | | | X | X | X | X | | |

 Function allocation of control inputs

| Functions | di1 | di2 | di3 | di4 | di5 | di6 | di7 | di8 | di9 | di10 | di11 | di12 |
|--|-----|-----|-----|-----|-----|-----|-----|-----|-----|------|------|------|
| Wint / Wext | X | X | | | | | | | | | | |
| Tracking on / off | | X | | | | | | | | | | X |
| ΔW on / off | X | X | | | | | | | | | X | |
| w / W2 | X | X | | | | | | | | | | X |
| Auto / Man | X | X | | | | | | | | | | |
| PI / P | X | X | | | | | | | | | | |
| Y / Y2 | X | X | | | | | | | | | | |
| Controller on / off | X | X | | | | | | | | | | |
| Programmer Run / Stop | | | | X | | | | | | | | |
| Programmer Reset | | | | | X | | | | | | | |
| Selection of programs | | | | | | X | X | | | | | |
| Remote / Local | | | X | | | | | | | | | |
| Parameterset | | | | | | | | X | X | | | |
| OVC+ (Three-point stepping controller) | | | | | | | | | | X | | |
| OVC- (Three-point stepping controller) disabling ¹⁾ | X | X | | | | | | | | | X | |
| OVC off/on | | | | | | | | | | X | | |

 Function allocation of outputs

| Functions | OUT1 | OUT2 | OUT3 | OUT4 | OUT5 | do1 | do2 | do3 | do4 | do5 | do6 |
|---|------|------|------|------|------|-----|-----|-----|-----|-----|-----|
| Controller output 1 | X | X | X | X | X | | | | | X | |
| Controller output2 | X | X | X | X | X | | | | | | X |
| Alarm 1 | X | X | | X | X | | | | | | |
| Alarm 2 | X | X | | X | X | | | | | | |
| Alarm 3 | X | X | | X | X | | | | | | |
| Alarm 4 | X | X | | X | X | | | | | | |
| Process values (x1, x2, x3, x _{eff}) | X | | X | | | | | | | | |
| Set-points (w, w _{eff} , w _{ext} , dw _{ext} , w _p) | X | | X | | | | | | | | |
| Control deviation (xw) | X | | X | | | | | | | | |
| Correcting variable Y _{pid} | X | | X | | | | | | | | |
| Position feedback (Y _p) | X | | X | | | | | | | | |
| Contr. outputs 1 | | | | X | X | X | | | | | |
| Contr. outputs 2 | | | | X | X | | X | | | | |
| Contr. outputs 3 | | | | X | X | | | X | | | |
| Contr. outputs 4 | | | | X | X | | | | X | | |
| Program end | | | | X | X | | | | | | |
| Status auto/man | | | | | | | | | | X | |
| Status W _{int} /W _{ext} | | | | | | | | | | | X |

1) auto/manual key disabling, set-point adjustment, controller switch-off, value adjustment and programmable controller operation.

6 Set-point functions

6.1 Terminology

| | | |
|--------------------|---|--------|
| w | internal set-point | |
| we | external set-point | |
| wp | programmer set-point | |
| W2 | second (internal) set-point | |
| W _{eff} | effective set-point | |
| SW _{i/e} | signal source for "internal/external" set-point switch-over | C. 190 |
| Sw/W2 | signal source for "weff / W2" set-point switch-over | C. 190 |
| SW _d on | set-point offset switch-on | C. 190 |
| S W _d | signal source for set-point offset | C. 180 |
| W _d | set-point offset type | C. 106 |
| SW _{ext} | signal source for external set-point | C. 180 |
| WTrac | tracking function switch-on | C. 106 |
| STrac | signal source for tracking | C. 190 |
| WSel | automatically selected lowest or highest set-point | C. 106 |

6.2 General

The following set-point functions are selectable during configuration C.100 using parameter WFunc.



In addition to the described effective set-points, switching over to the second set-point W2 is possible. Switch-over is via signal source Sw/W2 determined in configuration parameter C.190.

Set-point (WFunc = 0)

With set-point control, the set-point is determined by internal set-point **W**.

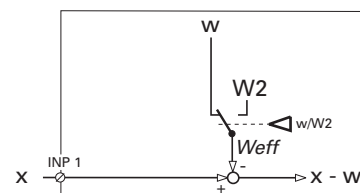

Set-point/cascade (WFunc = 1)

With set-point/cascade control, switching over between internal set-point **W** and external set-point **We** is possible. Switching over is done via signal source **SW_{i/e}** determined in configuration parameter **C. 190**.

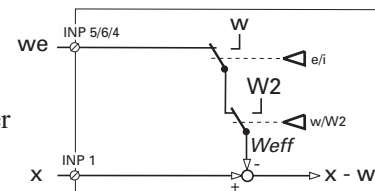

Programmer (WFunc = 2)

With programmer control, the set-point is determined by the internal programmer **Wp**. Switching over to the internal set-point **W** is possible and must be done via the signal source **SW_{i/e}** determined in configuration parameter **C. 190**.

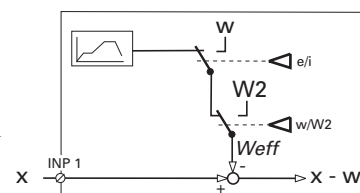

Set-point with external offset (WFunc = 3)

With set-point control with external offset, the effective set-point is determined by internal set-point **W**, however, it can be affected by external offset **dW**. The type of offset (additive or factor) is determined during configuration **C. 106** by parameter **dW**. The offset is switched on via signal source **SW_don** determined in configuration parameter **C. 190**.

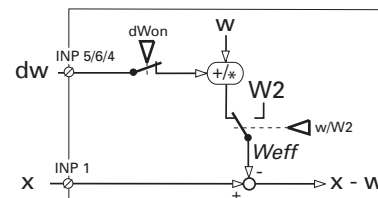

6.3 Detailed set-point function block diagrams

The following set-point function block diagrams illustrate the interactions of configuration parameters and possible control operations.

Fig.: 13 Set-point control $\mathcal{L}.100$; $WFunc = 0$

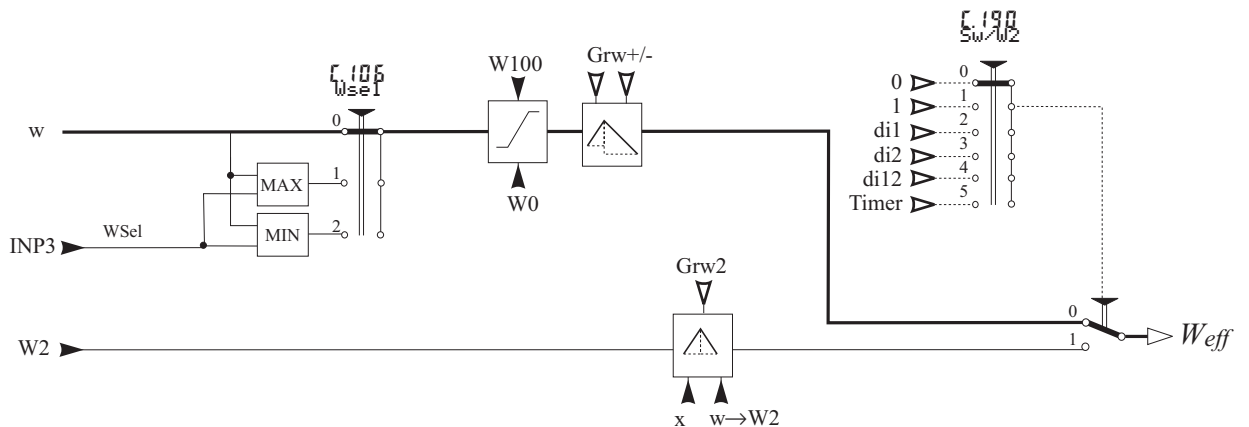

Fig.: 14 Setpoint / cascade control or programmer $\mathcal{L}.100$; $WFunc = 1$ or 2

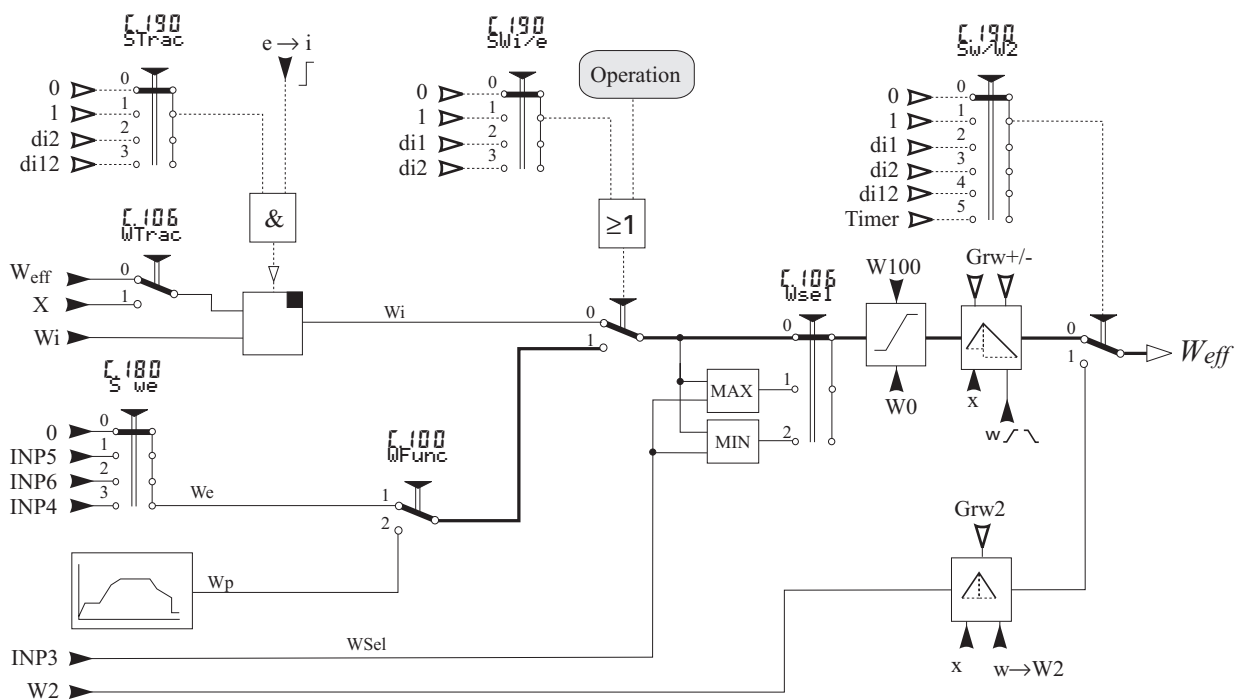

Fig.: 15 Set-point control with external offset $\epsilon_{.100}$; WFunc = 3

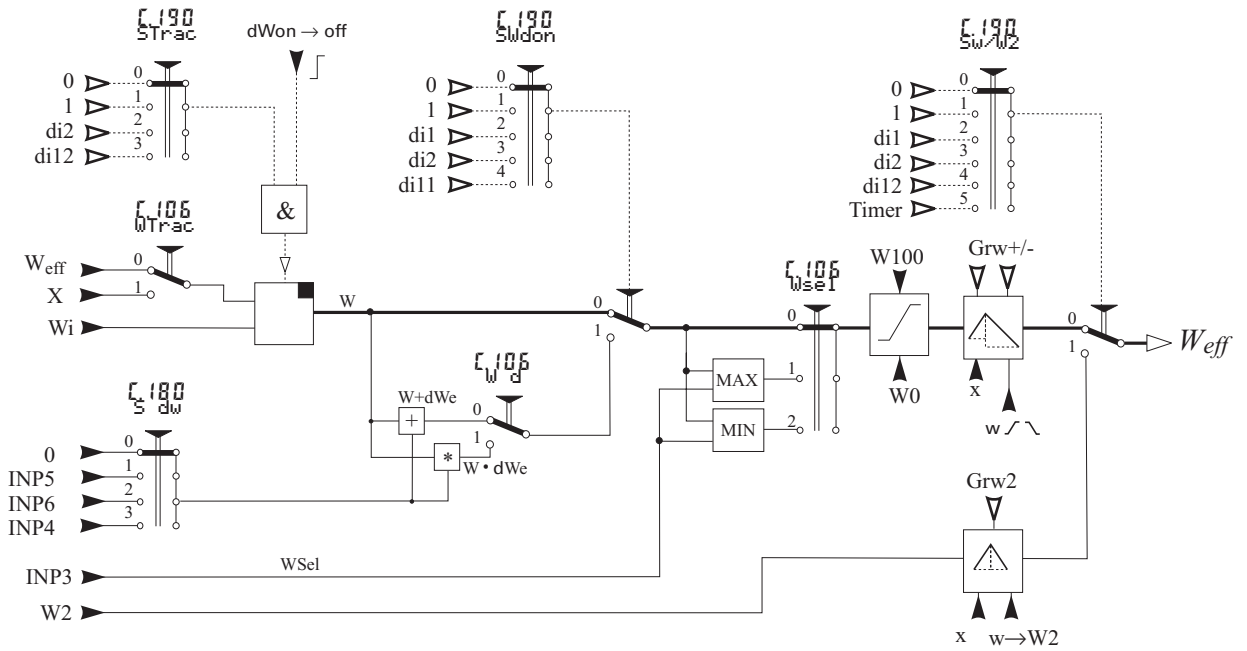

Fig.: 16 Setpoint / cascade control with offset $\epsilon_{.100}$; WFunc = 4/5

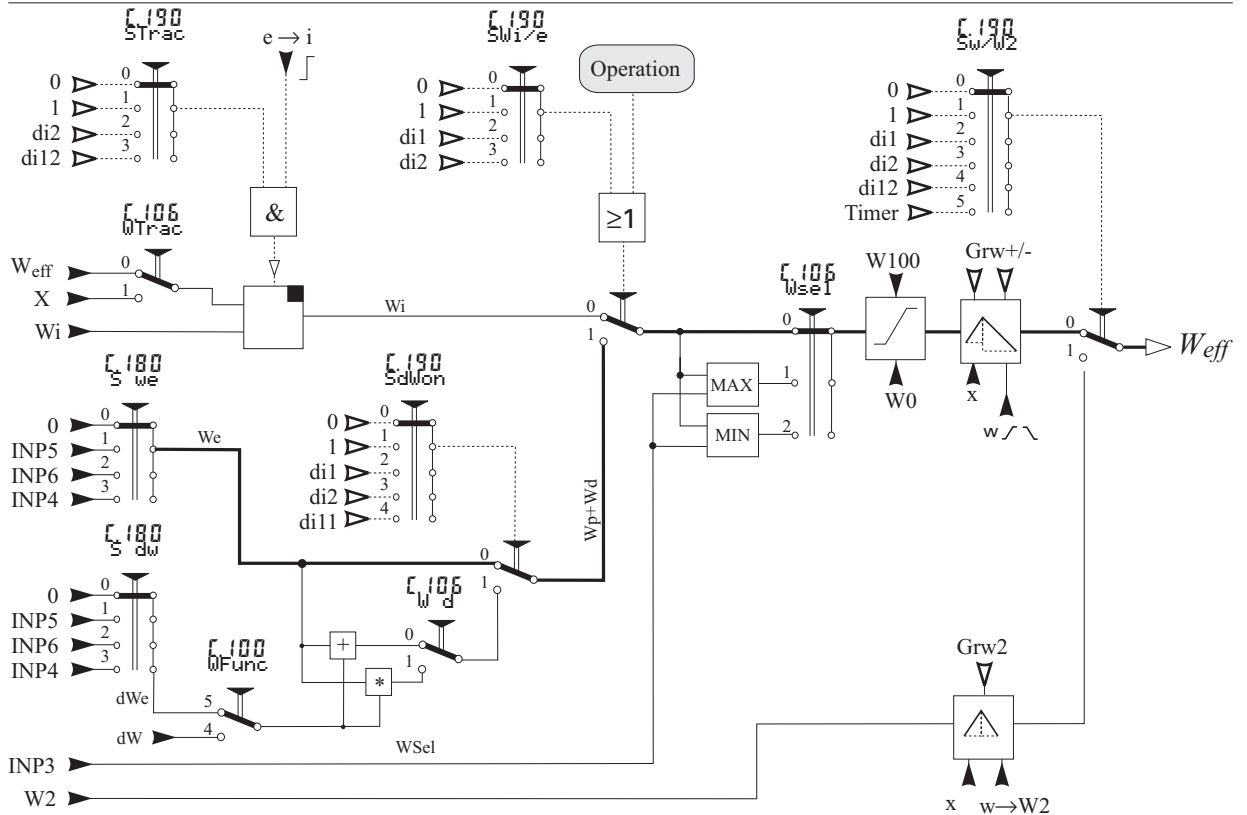
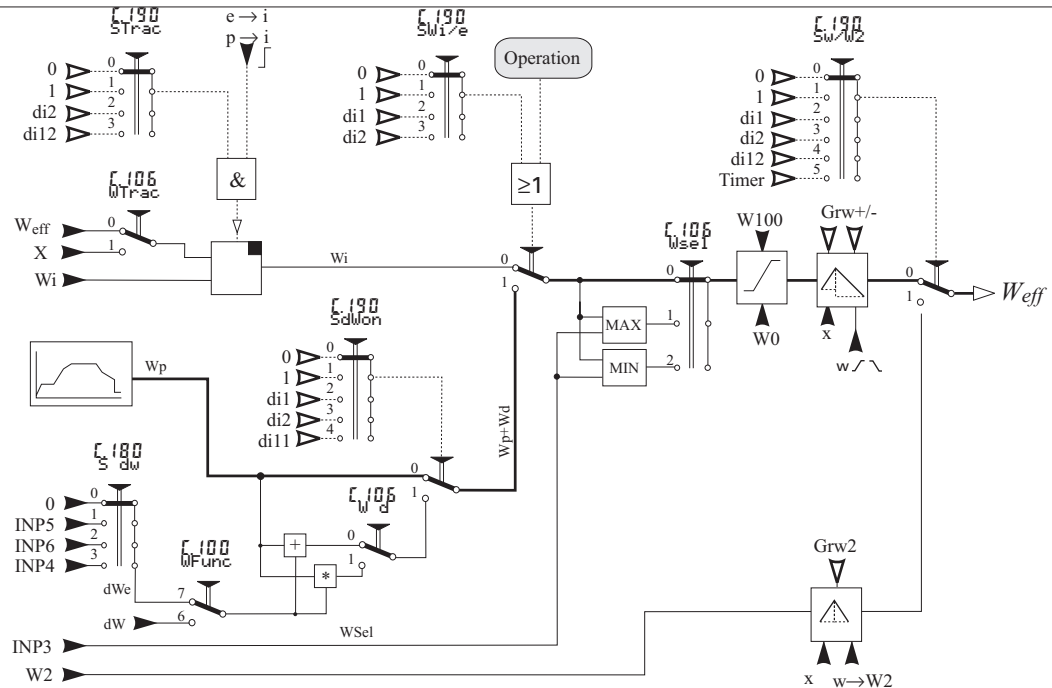

Fig.: 17 Programmer with ext. or int. offset $\Sigma.100$; WFunc = 6/7

6.4 Safe set-point W2

Second set-point W2 can always be activated with highest priority.

In the past, W2 was called “safe set-point”. Whether W2 can have safety functions, or whether it is only a pre-defined start position in defined process conditions is determined only by the way it is used and integrated into an automation concept.

Dependent of configuration, switch-over to set-point W2 is possible via interface, front operation, timer or one of control inputs di1, di2 or di12 ($\rightarrow \Sigma.190$).



Second set-point W2 is handled with priority. If W2 was selected anywhere (front panel, interface or the relevant control input), switching over at another facility is not possible.

6.5 External set-point Wext

Dependent of configuration, switching over between internal and external set-point via interface, front panel operation or one of control inputs di1 or di2 is possible ($\rightarrow \Sigma.190$). For making the external set-point effective, a 1 signal (24 V) must be connected on the int/ext contact. For activating the internal set-point, a 0 signal (0V) must be applied to the int/ext contact.

Analog input “Wext” is connected to INP5, however, it can be configured also for INP4 (galvanically isolated) or INP6 (yp input) ($\rightarrow \Sigma.180$), if necessary. Signal pre-processing (Func1, Func2) permits adjustment of the required set-point or correction characteristic as a function of the input signal. (dependent of configuration: \rightarrow INP5 $\Sigma.370$, INP4 $\Sigma.420$ or INP6 $\Sigma.470$).



Internal set-point W has priority. If the internal set-point was selected anywhere (front panel, interface or the relevant control input), switching over to external set-point We at another facility is not possible.

6.6 Set-point offset

The Set-point offset (internal dW or external dWe) can be added to the effective set-point or multiplied by it (\rightarrow [§. 105](#); [dW](#)). Examples for an additive set-point offset are “reduced stand-by set-point” and “outside temperature-dependent supply temperature control”. Set-point offset as a factor can be used e.g. for split load or O2 correction.

Dependent of configuration, the set-point offset can be triggered via interface, front panel operation, or via one of control inputs $di1, di2$ or $di11$ (\rightarrow [§. 190](#); [SdWor](#)). For activating the set-point offset, a 1 signal (24 V) must be connected to the relevant contact.

For de-activating the set-point offset, a 0 signal (0V) must be applied to the contact.

Analog input “S Wd” is connected to INP5, however, it can be configured also for INP4 (galvanically isolated) or INP6 (yP input) (\rightarrow [§. 180](#); [SdW](#)), if necessary. Signal pre-processing (Func1, Func2) permits adjustment of the required set-point or correction characteristic as function of the input signal. (dependent of configuration: \rightarrow INP5 [§. 370](#), INP4 [§. 420](#) or INP6 [§. 470](#))



“Offset activated” has priority. With selection “offset active” at anywhere (front panel, interface or the relevant control input), switching over at another facility is not possible.

6.7 Bumplessness

6.7.1 Set-point change

Set-point change in both direction is always bumpless. The effective set-point W_{eff} approaches the modified set-point (target) linearly, whereby gradients $Grw+$ and $Grw-$ adjustable at parameter level determine the slope. The gradient function is also active with programmer, however, it is not effective as long as the program profile causes slower set-point changes than the adjusted gradients. Hereby, the gradient setting can be used as safety function with incorrectly adjusted programmer.

For second set-point $W2$, an independent gradient $Grw2$ which is valid for the two switch-over directions was introduced.

The gradient function is switched off with $Grw+$ and $Grw-$ or $Grw2$ set to “----”.

Fig.: 18 Ramp function with set-point change

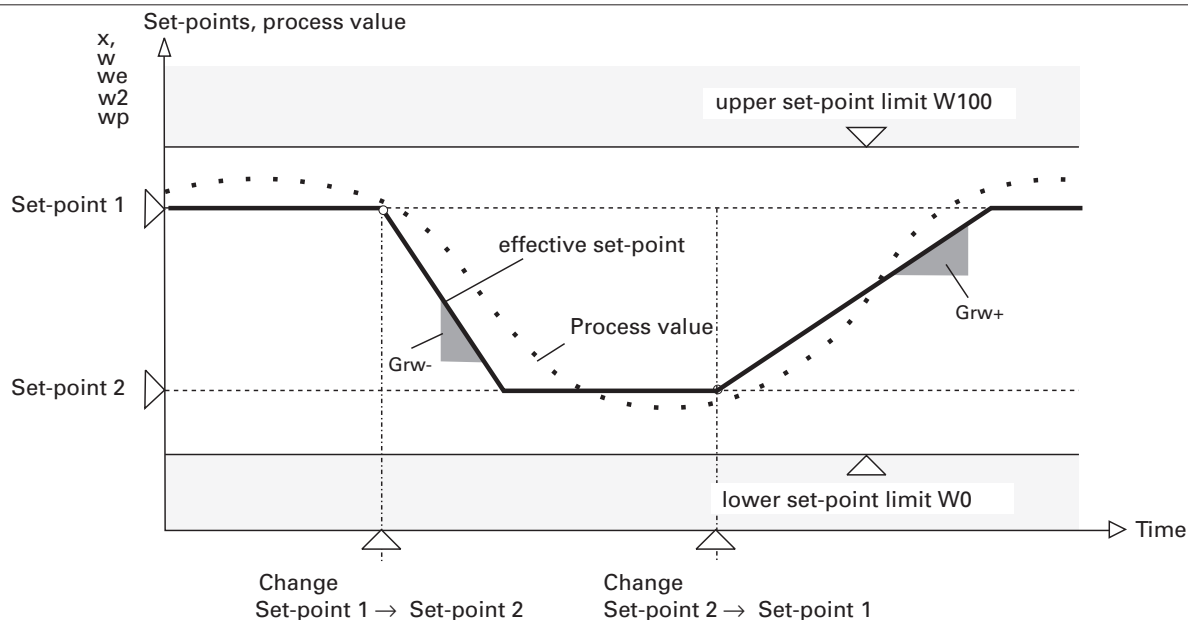

6.7.2 Set-point switch-over ($w/w2$, $Wext/Wint$, w/wp , Controller 'On')

Control with the new set-point starts linearly from the instantaneous process value. The slope of the ramp is determined dependent of direction by $Grw+$, $Grw-$ or $Grw2$. This is also valid, if the process value at switch-over time is out of the adjustable set-point range $W0/W100$ (e.g. during start-up).

i In this case, controller 'On' means controller power supply switch-on. For activating the gradient with controller signal 'SCoff = On $GrwOn$ must be used (\rightarrow see also page 59).

Fig.: 19 Ramp function with set-point change

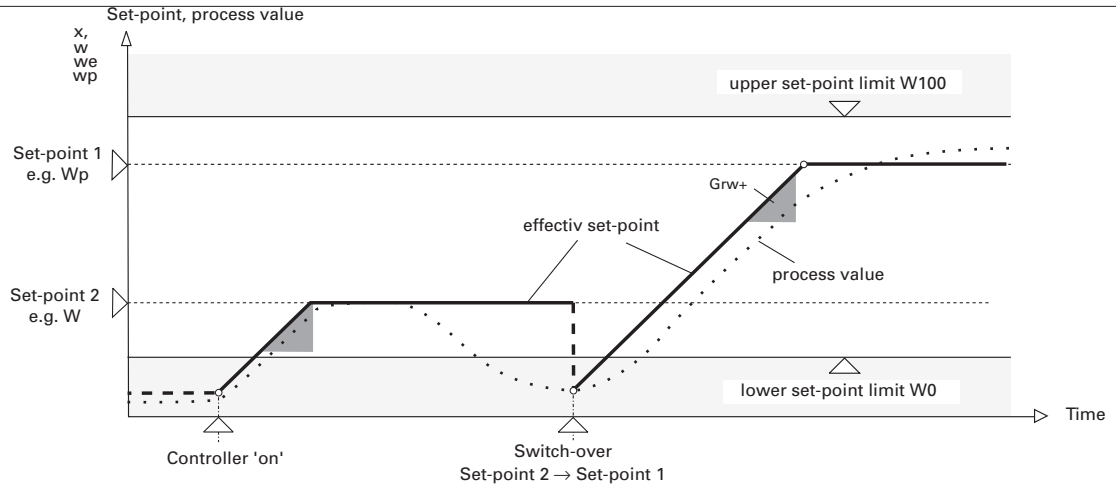

6.8 Tracking

6.8.1 Set-point tracking (\rightarrow §. 105)

When switching over between the various set-points (We and Wp), undesirable set-point steps may occur. These steps can be attenuated using the set-point tracking function.

With set-point tracking, the we/wp used so far is stored as internal set-point ' w ' when switching over from we or $wp \rightarrow w$. When switching back ($w \rightarrow we$ or wp), start-up is dependent of $Grw+/-$ we or wp setting (see \rightarrow Fig.: 20).

The actual controller behaviour, process value or set-point tracking, is determined in configuration code §. 105; $WTrac$.

Dependent of configuration, this setting can be triggered via interface, front-panel operation or one of control inputs $di2$ or $di12$ (\rightarrow §. 190). However, only the switch-over type is prepared at this facility, without selecting between internal and external set-point.

For preparing the bumpless switch-over, a 1 signal (24 V) must be connected to the external contact. For direct switch-over, a 0 signal (0 V) must be applied to the contact.

i Bumpless switch-over has priority. With bumpless switch-over selected anywhere (front-panel, interface or relevant control input), switch-over at another facility is not possible.

Fig.: 20 Set-point tracking with switch-over to internal setpoint

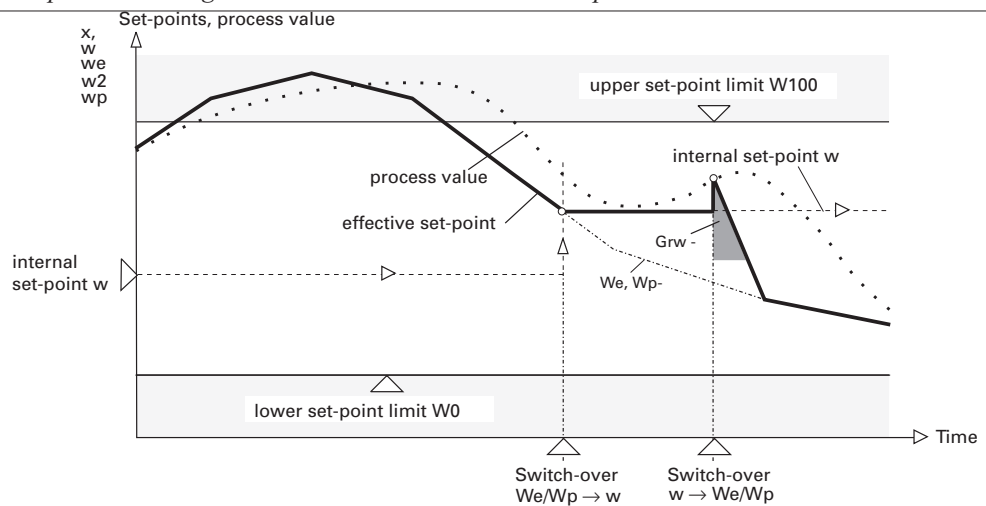

6.8.2 Process value tracking

The set-point may be far away from the instantaneous process value (e.g. during start-up). In this case, the process value tracking function can be used for attenuation of the step which may occur. Process value tracking causes storage of the process value as set-point, whereafter line-out to the actually required set-point is done slowly according to parameters Grw +/-.

Whether process value or set-point tracking is required is determined in configuration code C.106 - WTrac. Dependent of configuration, this setting can be made via interface, front panel operation or one of control inputs di2 or di12 (→ [C. 190](#)).

However, the type of switch-over is only prepared at this facility, without actually selecting between external and internal set-point.

For preparing bumpless switch-over, a 1 signal (24 V) must be connected to the relevant contact. For direct switch-over, a 0 signal (0V) must be applied to the contact.



Bumpless switch-over has priority. With bumpless switch-over selected anywhere (front panel, interface or relevant control input), switching over at another facility is not possible.

Fig.: 21 Process value tracking with switch-over to internal set-point W

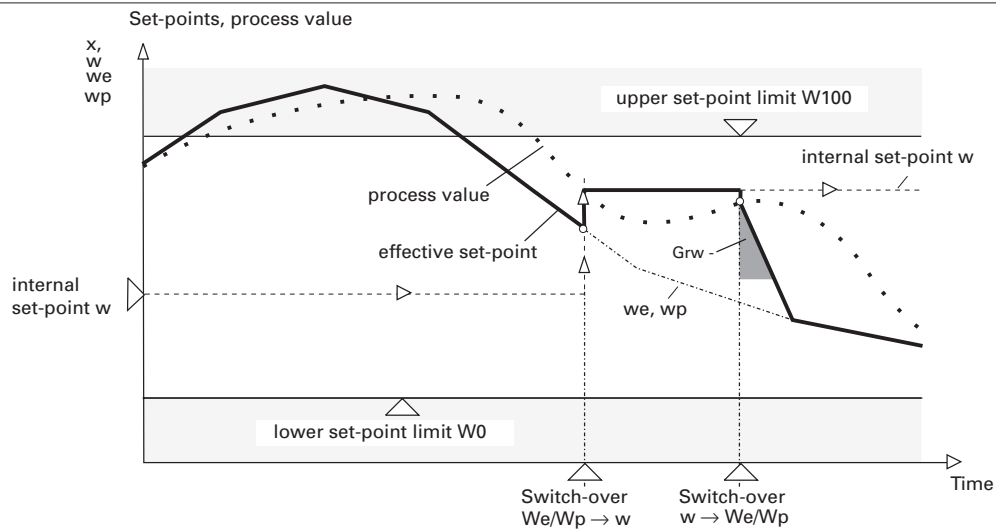

6.8.3 MIN/MAX selection WSel

Dependent of set-point WSel configuration, effective set-point W_{eff} can be prevented from being below or above the value determined by analog input INP3 (→ [C. 106](#)).

This function can be used, for instance, during combustion control, whereby excess air is indispensable (crosswise interlocking of air and fuel supply).

The min/max selection can be activated also with set-point functions varying from those shown below.

Fig.: 22 Min/Max selection with internal offset

Fig.: 23 Min/Max selection with external offset

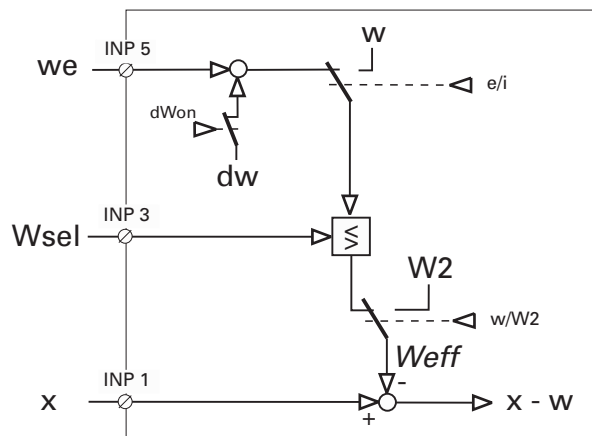
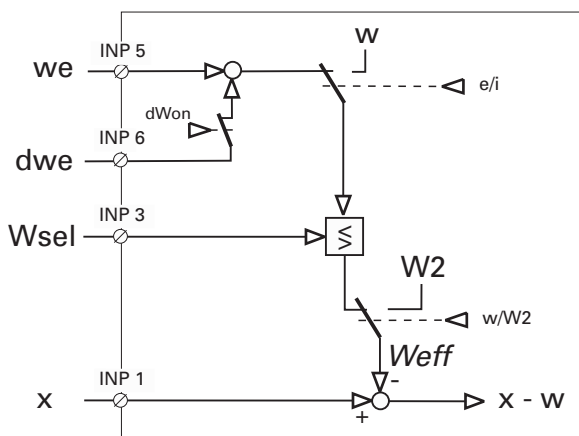

7 Process value calculation

7.1 Standard controller

The process variable measured via analog input INP1 and processed, if necessary, using functions Func1 and Func2 is used as process value x by the controller.

Fig.: 24 Standard controller

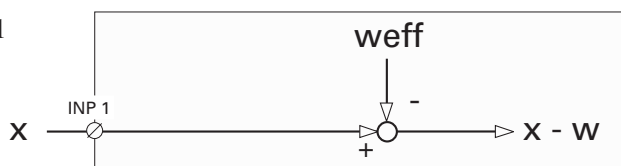

7.2 Ratio controller

Process control frequently requires various components to be mixed into a product. These components must be mixed according to a given ratio. The main component is measured and used as reference for the other components. With increasing flow of the main component, the flow of the other components will increase accordingly. This means that process value x used by the controller is determined by the ratio of two input variables instead of being measured as one process variable.

For optimum combustion, the fuel-air ratio must be controlled. With stoichiometric combustion, the ratio is selected so that there are no residues in the waste gas. In this case, the relative instead of the physical ratio is displayed as process value and adjusted as set-point l . If the transmitters used by the controller use a stoichiometric ratio, $l = 1$ is exactly met with restless combustion. With a process value display of 1,05, the instantaneous air excess is clearly 5%.

The amount of air required for atomizing is taken into account by constant N_0 (Para → Input → IstW → N0).

For selecting a ratio controller, the $\lambda = 1$ in $\lambda \cdot x_2$ must be entered. Moreover, configuration words $\lambda \cdot 100$ must be taken into account.

7.2.1 Conventional ratio control:

Calculation so far required scaling of the ratio variables for a range of 0...100 % (x_0, x_{100}).

If this method shall remain unchanged, factor “s” must remain unchanged with respect to factory setting “s = 1”.

In this case, the control deviation is formed according to relation

$$xw = (x_1 + N_0) - \lambda \cdot x_2$$

In this case, the physical (%) and the relative ratio are identical so that the displayed process value x_1/x_2 also corresponds to the relative ratio. Everything is as usual. The individual flow rates can be displayed with unit “%” at the extended configuration level.

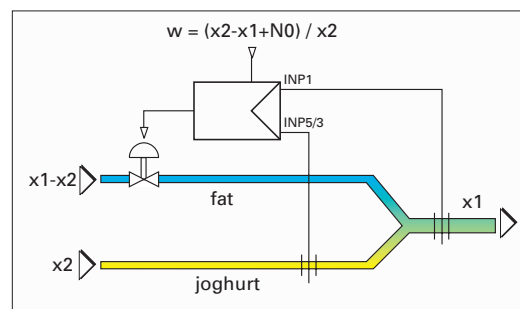

7.2.2 Additional possibilities of ratio control with KS92/94

The two requirements, i.e. control of the relative ratio and display of the material flow rates in physical units are met by means of the material-specific (stoichiometric) factor “s”. For display of the individual material flow rates in physical units (e.g. Nm^3/h) at the extended operating and display level, the two flow rates available as mA signals are scaled in physical units, i.e. they can also be displayed directly, e.g. in Nm^3/h . Set-point W_{eff} effective as a relative ratio is multiplied by the stoichiometric factor (e.g. $s = 10$). This means that “stoichiometric” material flow ratios can be used for calculating the control deviation. The instantaneous (controlled) process value is calculated from the physical ratio, multiplied by $1/s$ and displayed as a relative value.

(see also Fig.: 26, example: standard ratio control)

Selecting the individual material flow rates:

For display of the individual material flow rates in physical units, the “extended operating level” must be selected. At this level, the individual inputs, e.g. INP1 for x_1 and INP3 for x_3 can be shown on display 2 (set-point display).

 The effective X_p refers to the process value range ($x_0...x_{100}$) of input x_1

7.2.3 Example for standard ratio control:

Standard ratio control at the example of a stoichiometric combustion.

Analog input INP1 is configured for 4...20 mA with physical unit m³/h (air) (E.200). Values 0 and 1000 (E.211 and E.212) are allocated to input variables 4 mA (x0) and 20 mA (x100). Atomizing air N0 is added to this input. Selection between INP3 and INP5 (E.180; SX2) as second ratio input is possible. This input is also configured for 4...20 mA and m³/h (gas) (E.300 / E.400). x0 and x100 values 0 and 100 (E.311 / E.411 and E.312 / E.412) are allocated to the input variables.

Set-point Weff effective as a relative ratio is multiplied by the stoichiometric factor s (e.g. s = 10) (E.110) so that a "stoichiometric" flow ratio can be used for calculation of the control deviation. The instantaneous (controlled) process value is determined from the physical ratio, multiplied by 1/s and displayed as a relative value.

Fig.: 25 Stöchiometrische Verbrennung

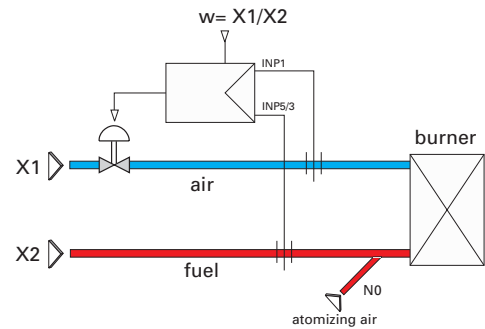
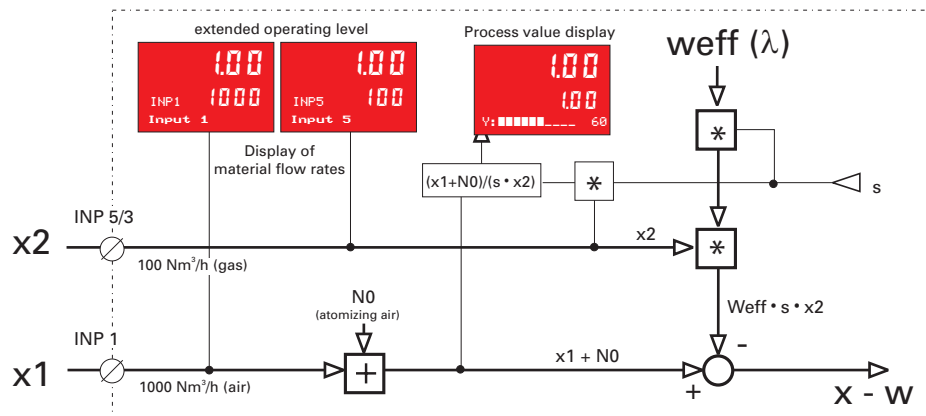

Fig.: 26 Ratio control (standard)



7.2.4 Material batching and mixing

The following examples are intended to show that various control possibilities can be used. This is necessary, since the materials to be mixed (e.g. paste) are not always directly measurable due to their consistency. Other cases may require a component to be controlled relatively to a total and not as a ratio to another component.

$w = x1/x2$

The first case is obvious. Almost everybody knows what happens during brewing. Yeast (x2) must be batched in a ratio to the original wort (x1). The set-point is adjusted in "‰ yeast", e.g. w = 3 ‰.

The ratio inputs are scaled in equal units. The control deviation is multiplied with "s = 0,01" and calculated according to equation $xw = (x1 + N0) - 0,03 x2$ so that exactly 3 ‰ of yeast are batched with $xw = 0$.

Process value display is also in ‰. Constant N0 is without importance (N0 = 0).

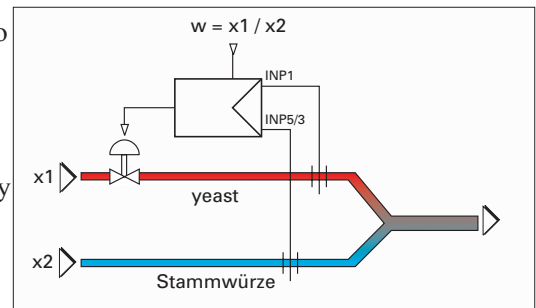

$$w = x1/(x1+x2)$$

In this example, water (x1) must be batched as a percentage of the total (paste; x1+x2).

As the paste quantity is not available directly as a measurement signal, the total is calculated internally from x1 and x2.

$N_0=0$ must also be adjusted in this case.

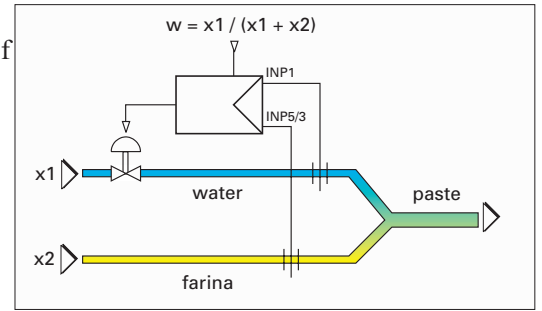
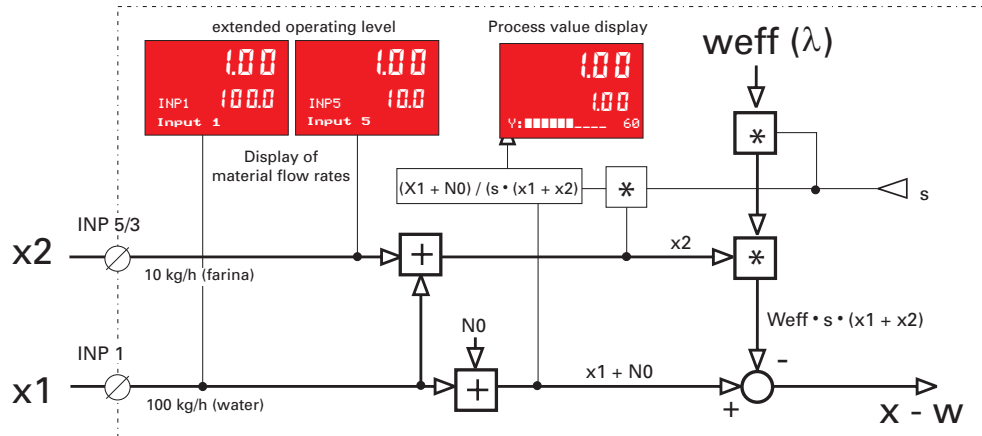

Fig.: 27 Ratio control = $x1/(x1+x2)$



$$W = (x2 - x1 + N0) / x1$$

Unlike the previous examples, yoghurt (x2) and the final product (x1) are measured in this case.

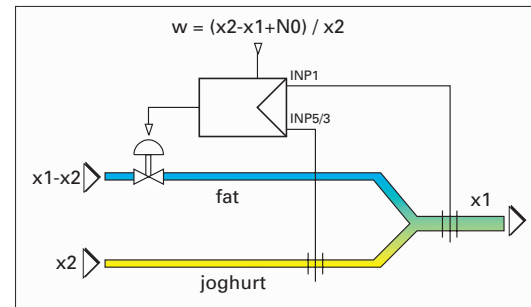
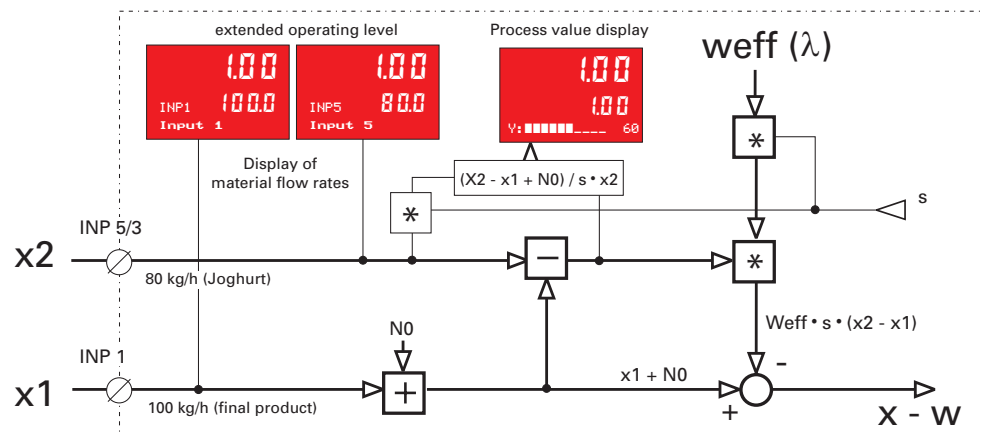

Fig.: 28 Ratio control = $(x2 - x1 + N0) / x2$



7.3 Three-element control

With three-element control, process value calculation is according to equation

$$x = x1 + a \cdot (x2 - x3) \quad (\text{Para} \rightarrow \text{Input} \rightarrow \text{IstW} \rightarrow a)$$

whereby term $(x2 - x3)$ is the difference between the steam and water flow rates.

Factor b for flow range matching used so far is omitted, because the mA signals are directly converted into physical units during input value processing (x_0, x_{100}).

Main variable $x1$ (level) is displayed on the process value display, however, switch-over to calculated process value x is possible at the extended operating level (start-up and set-up).

For selecting a three-element controller, the $\text{ETYP} = 2$ in E. 100 must be entered.

Fig.: 29 Example for three-element control

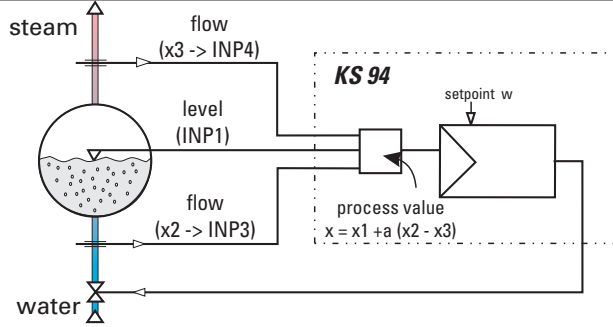
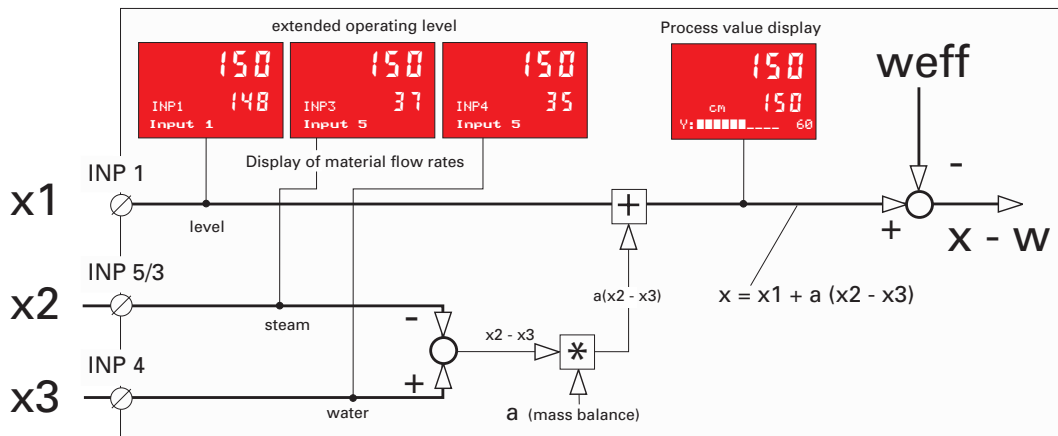

Fig.: 30 Block diagram for three-element control



7.4 Mean value

For controlling a process purposefully, the correct process value (for the product) must be used. When measuring e.g. the temperatures at two different points in a furnace, mean value formation can be used for process value determination.

The mean value is calculated according to equation: $x = (1 - b) x1 + b x2$.

Parameter b can be used for determining a weight ratio for the two signals.

If $b = 0,5$ is entered, the arithmetic mean value is calculated.

Fig.: 31 Mean value formation (furnace)

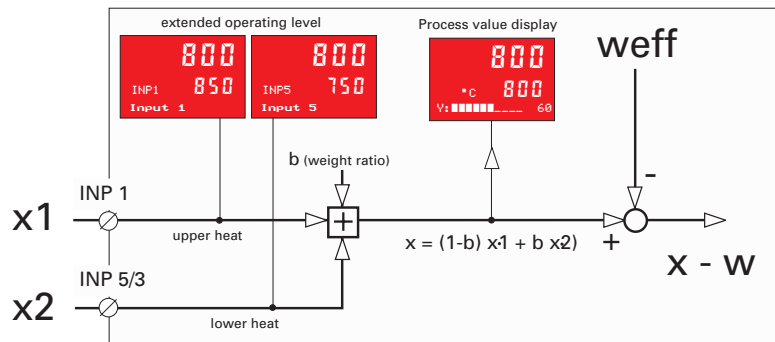

8 Correcting variable processing

The following considerations in connection with correcting variable processing are valid for continuous controllers, two-point, three-point and three-point stepping controllers. The following diagram shows the functions and interactions of correcting variable processing.

Fig.: 32 Y_p signal

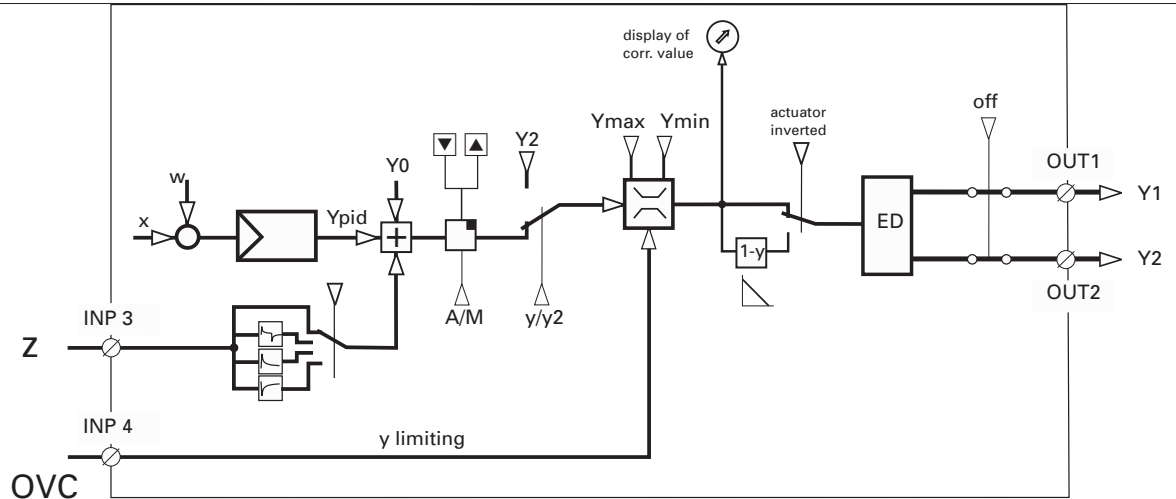

8.1 Second correcting value

Similar to set-point processing, switch-over to a second preset correcting value Y_2 is possible. The signal source for y/Y_2 switch-over must be selected with [19] .

Whether Y_2 has safety functions, or whether it is only a pre-defined start position in defined process conditions is determined only by the use and integration into an automation concept.

$Y_2 \rightarrow Y$ switch-over is bumpless.

8.2 Correcting variable limits

Parameters Y_{\min} and Y_{\max} determine the limits of the correcting variable range within 0...100 %. With three-point and continuous controller "split range", the correcting variable limits are within -100 ... +100 %. The minimum separation of Y_{\min} and Y_{\max} is one digit.

Fixed correcting variable limits are specified with parameters y_{\min} and y_{\max} .

Fig.: 33 Fixed positioning limits

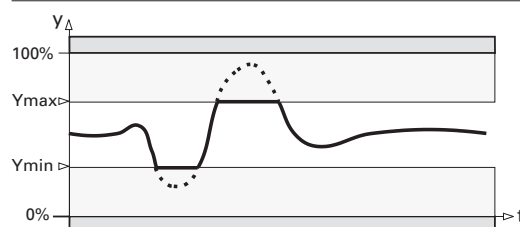

8.3 External correcting variable limiting (override control)

Either the lowest (OVC-) or the highest correcting value (OVC+) can be limited by an external current signal (INP4) (Fig. 35). Override control is used where bumpless switch-over to another controller when reaching defined process conditions, mainly according to other criteria, is required. The basic principle is that two controllers act on the same motor actuator.

Fig.: 34 Maximum value limiting

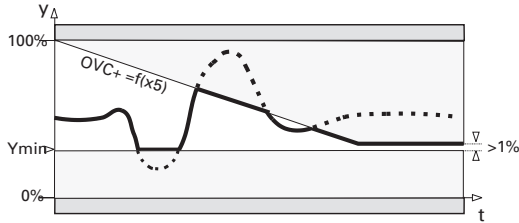
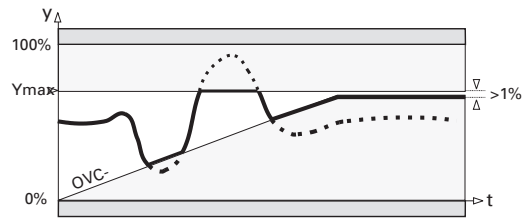

Fig.: 35 Minimum value limiting



8.4 Override control

8.4.1 Override control with continuous output

i Limiting control with three-point stepping output is possible by configuring a "continuous controller with position control" (→ section page 71) and by limiting the correcting variable via INP4 (→ section 8.3). For this, option card "C" is required.

Fig.: 36 Override control with continuous output

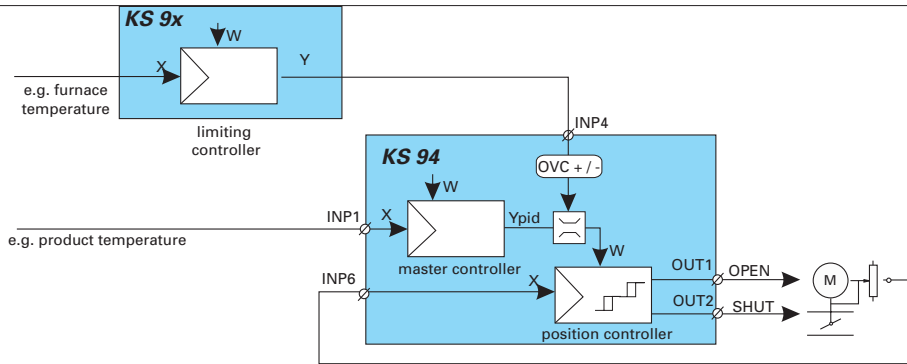

8.4.2 Override control with three-point stepping output

Override control with three-point stepping output can be realized in the same way, by configuring a "continuous controller with position control" (Fig. 37).

Override control is also possible using a classical three-point stepping controller, however, option "C" is required for this limited controller. The positioning signals of the limiting controller must be connected as shown in Fig.: 37 opposite.

Selection which of the two controllers is activated in the process is made by the logic of the slave controller. The first "CLOSED pulse" coming from the limiting controller switches over to override control. The limited controller will be re-activated automatically, when further closing of the motor is required for the first time.

Via additional analog output OUT3 (option C), the motor position can also be transmitted as a mA signal to and displayed on the master controller.

Fig.: 37 Override control with 3-point stepping controllers

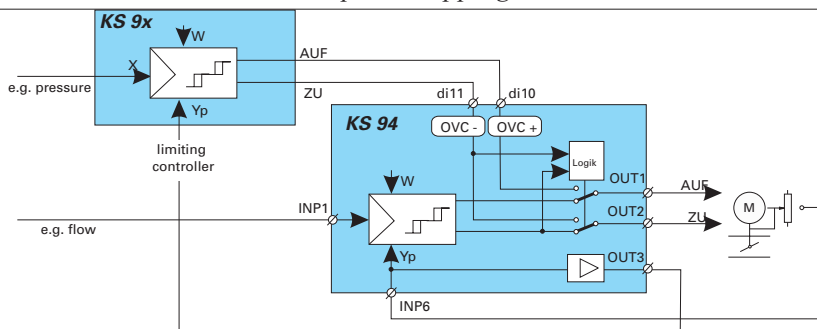

8.5 Bumpless A/M switch-over

Sudden process interventions by control mode switch-over are usually not desired. Excepted is purposeful switch-over $y \rightarrow Y_2$.

A \rightarrow M switch-over is always bumpless; the last correcting value is frozen and can be changed manually. The M \rightarrow A switch-over is different. Correcting value differences are compensated as follows: when switching over, the integral action of the controller is set to the correcting value Y_M output last plus correcting variable portions of the controller P and D action running in the background ($Y_I = Y_M + Y_{PD}$). Now, only the integrator, which slowly adapts the correcting variable to the stationary value according to the actual control deviation is active.

Until the D action has decayed completely, the adaption can be delayed or accelerated.

Fig.: 38 Bumpless switch-over

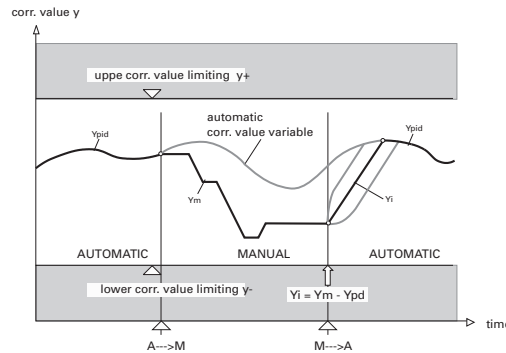

8.6 Motor actuator output action

For safety reasons, motor actuators may operate inversely, i.e. they may be self-opening in case of positioning signal failure (e.g. combustion air with furnaces). Although the process is clearly a “heating process”, i.e. the controller action should be inverse, “direct” action would have to be adjusted.

Inverting motor actuators can be taken into account by reversing the action of positioning output OUT. With switching outputs (relay or logic) “direct” is the normally open and “inverse” the normally closed operating principle.

The controller output action is inverse, as usual (e.g. heating) or direct (e.g. cooling). Thereby, correcting variable display and increment/decrement keys correspond to the actual energy or mass flow direction.

Fig.: 39 Normal ‘heating’ - process

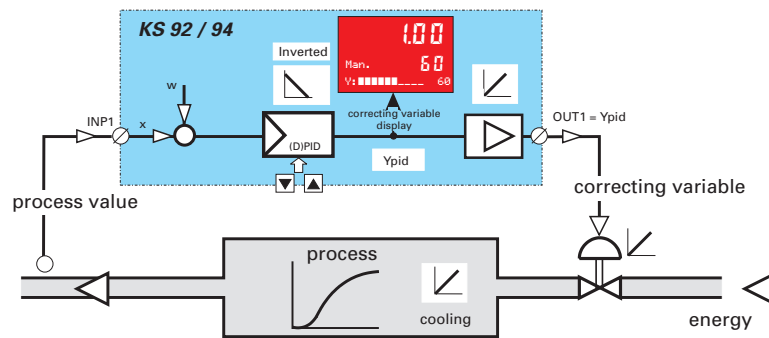

Fig.: 40 Normal ‘cooling’ - process

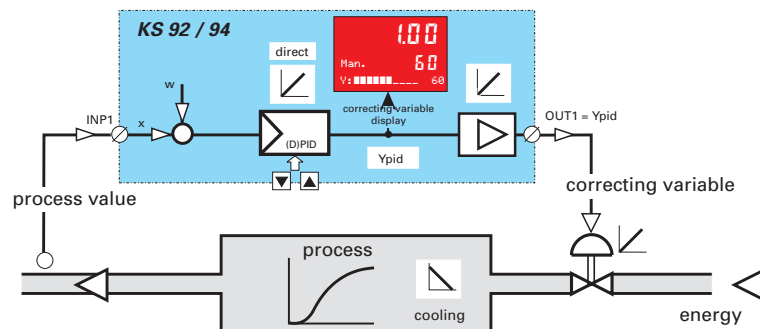
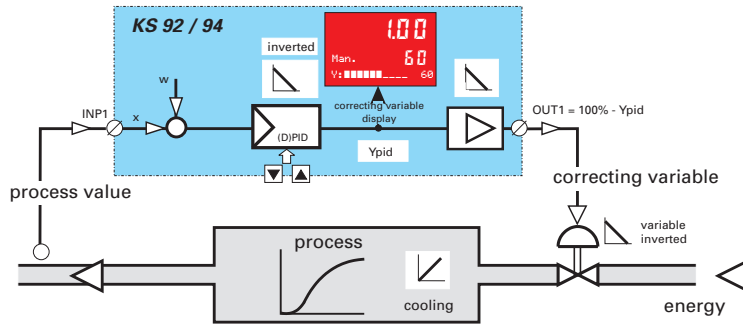

Fig.: 41 'Heating' process with inverting actuator



8.7 Positioning output switch-off

The controller positioning outputs can be switched off as a reaction to sensor error, via control input and by the timer of the real-time clock (configurable).

8.8 Controller output action with sensor break

Dependent of configuration, sensor break causes (C. 10 t)

- positioning output switch-off
- output of the lowest correcting value
- output of the highest correcting value
- output of the second correcting value Y2

8.9 Position feedback Yp:

The position feedback can be used for detection of the position e.g. of the motor actuator or of the valve. Position feedback Yp can be connected either as a potentiometric transducer or as a 0/4...20 mA standard current signal.

Analog input Yp can be configured for INP6 (→ C.450).

The position feedback must be calibrated. This can be done in two steps for X0 or X100.

- Calibration for X0: Select $\times 0c$ as shown in Fig. below Press the selector key, the “c” on the display $\times 0c$ starts blinking. Now, bring the potentiometric transducer into the position for X0 (usually lower end position). The instantaneously valid value for INP6 appears on display 1. Press the selector key again to store this actual value as X0.
- Calibration for X100 must be done accordingly. Select $\times 100c$. Press the selector key. The “c” of the display $\times 100c$ starts blinking. Now, bring the transducer into the position for X100 (usually upper end position). The instantaneously valid value for INP6 is shown on display 1. Press the selector key again to store this actual value as X100

Fig.: 42 Selecting parameter $\times 0c$ / $\times 100c$

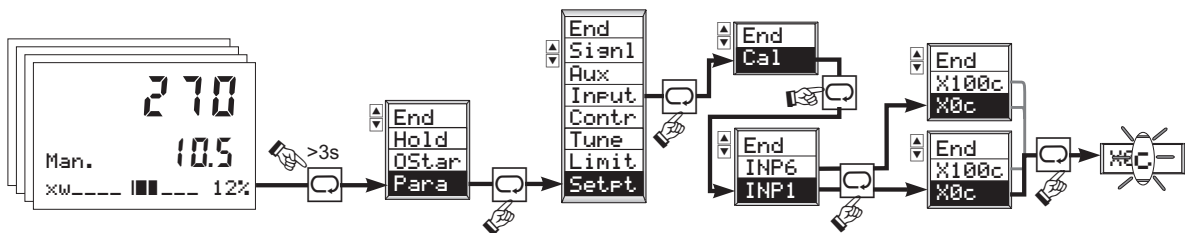

Position feedback yP as a potentiometric transducer

As a potentiometric transducer, a potentiometer is connected mechanically to the potentiometer. The potentiometer must be connected to the controller terminals. Energization is via terminals 0 % and 100 %. The voltage proportional to the motor actuator position is tapped via terminal yp. Resistance Rtotal, inclusive of lead resistances, must not exceed 1k[.

Position feedback yP as a 0/4...20 mA standard current signal

The input resistance is 50 [.

9 Special Functions

9.1 Control using a disturbance signal

Control with measurable disturbances z is used to improve the dynamic behaviour of slow processes with long delay times. It is configurable (C105) and can act either on the controlled process value or directly on the correcting variable without consideration of the control behaviour. Option C (INP 3) is required.

The pre-processed disturbance variable (Func1, Func2) can be used directly or after differentiation (parameter T_{dz}), whereby either both output actions, or only one are taken into account.

Fig.: 43

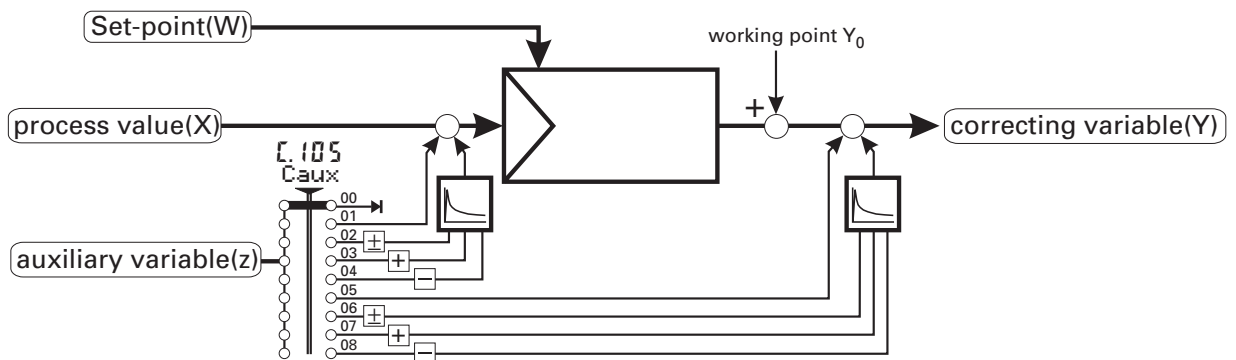

9.1.1 Y_p signal

According to the latest standard of information, there are two reasons for using the position feedback (control with three-point stepping output).

In some installations, the controlled process value must be lowered by several percent with increasing load. The reduction is identical with a “permissible tolerance”.

Furthermore, advantages may be gained mainly in slow processes with long delay time (avoidance or reduction of overshoot with important load changes).

Example: steam boiler

Nominal pressure: $P_N = 18 \text{ bar}$ at 50 % load

Pressure limits: 18,5 bar no load
17,5 bar full load

Measuring range: 0...20 bar \triangleq 4...20 mA (X_0 , X_{100} of INP1)

Solution

Three solutions are possible. All required functions are provided as standard.

- Simulation of an increased process value
 y_p (INP 6) is calibrated as usual (X_0 , X_{100}) and displayed as a position. As with every input, two-phase pre-processing is also provided in INP6. **C. 105** selects auxiliary variable z via INP6 (with or without differentiation).

Scaling $mx+b$ is used to calculate the correction characteristic (for **lowering** the set-point, a positive m and a negative b must be adjusted):

$$m = (18,5 - 17,5) \text{ bar} / 100 \% = 0,01$$

$$b = -1 \text{ bar}$$

- Lowering the set-point
As above, but “set-point/cascade with external offset dWe (**C. 100**)” is set. **C. 180** selects the INP6 as source of dWe . As the correction characteristic acts on the set-point, the polarity of m and b must be reversed. In this case, differentiation is not possible.

$$m = -0,01$$

$$b = +1 \text{ bar}$$

□ Position feedback as standard signal

With y_p measured via an external transmitter, connection of the current signal either as auxiliary variable z or as external set-point offset dW_{ext} to the relevant inputs and scaling it directly to the required correction range (z.B. 0...100 % = + 1...- 1 bar) with X_0/X_{100} is possible.

Fig.: 44 Y_p signal

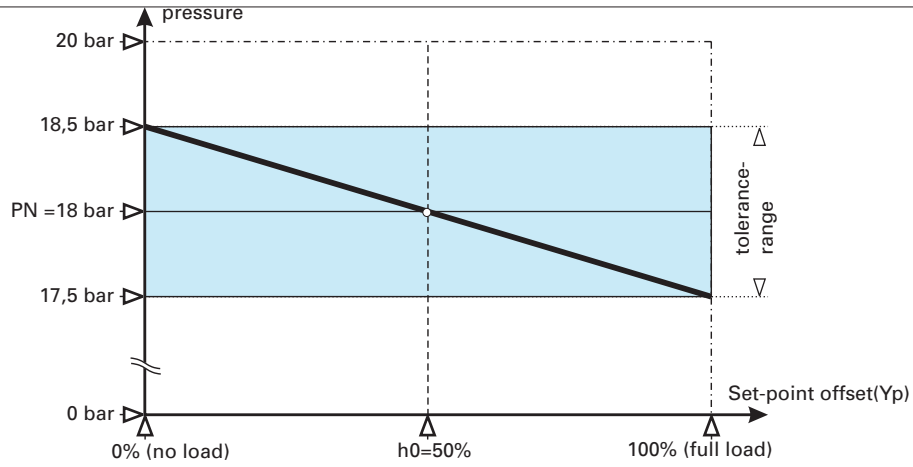
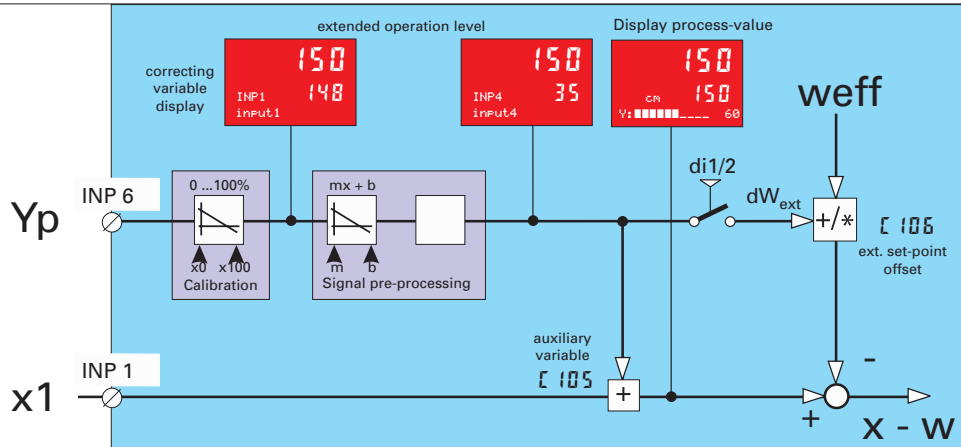

Fig.: 45 Block diagram for Y_p signal



9.2 “Rapid Recovery”

After short-term mains failure or plant trouble, the process might have deviated from its working point only minimally. With controller start without previous knowledge, the working point will be redetermined by evaluating the control deviation. As the control deviation might be very small, this will take rather a long time, i.e. there will be a “drop”. If the controller knows its old working point, start is possible using the right correcting variable for this working point, i.e. the working point will be reached again much earlier.

This is ensured by the “Rapid Recovery” function, which is divided into two independent functions. Function “Y storage and Y tracking” ensures the approach to the correcting variable required for the working point. With higher deviations of the control variable from the target set-point, function “X tracking” ensures smooth set-point line-out to the target set-point starting from the actual control variable.

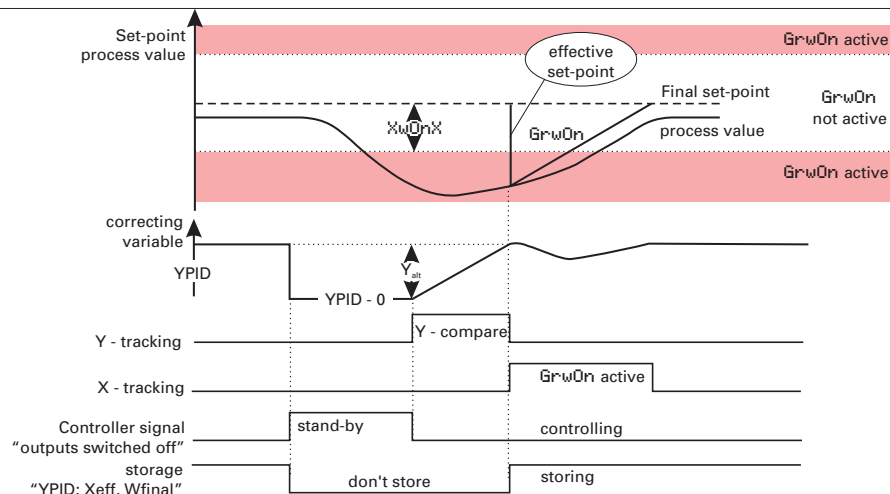

9.2.1 Y storage

For this, the controller continuously stores data on the actual working point (correcting variable, control variable, target set-point) in the capacitor-buffered RAM, which even provides back-up with mains failure of more than 6 hours. After mains failure or plant trouble, safe data on the working point are available. These data will be used by the controller to return to the working point sooner.

After power failure or plant disturbance, the controller goes to the correcting variable of the old working point automatically and starts controlling at the correcting variable. This is of particular advantage especially with three-point stepping controllers.

This function will show good results, if the interruption was “short”. As the term “short” must be considered in relation to the process time behaviour, however, the change of process value and set-point up to which Y calibration is required after power failure can be adjusted via the parameters. This is done using new parameter $XwOnY$. With three-point stepping controller without position feedback and signallers, this function is not provided!

| Parameter | Range | Default |
|-----------|----------------|------------------------------|
| $XwOnY$ | ----, 0...9999 | ---- (function switched off) |



“Y calibration is done with: $\{x < XwOnY$ and $\{w < XwOnY$

9.2.2 Set-point ramp after switch-on

The second rapid recovery sub-function is the set-point ramp. If the process value still deviates from the set-point by a value exceeding the adjustable parameter $XwOnX$ after controller enabling (according to configuration $[191; 5Loff = On \rightarrow$ see page 102), control to the set-point is via parameter $GrwOn$.

| Parameter | Range | Default |
|-----------|----------------|------------------------------|
| $XwOnX$ | ----, 0...9999 | ---- (function switched off) |
| $GrwOn$ | ----, 0...9999 | ---- (function switched off) |



A set-point ramp is activated when: $xw > XwOnX$

9.3 DAC® = Actuator monitoring

”DAC® ensures operating safety **D**igital **A**ctor **C**ontrol monitors the actuator safety and detects problems before there would be an increased control deviation. Monitoring is done for blockage, defective motor or capacitor or for other actuator problems affecting its function. The DAC function is available for three-point stepping controllers with position feedback, continuous controllers with position control and continuous controllers with position feedback.”

Introduction

With all controller types featuring position feedback Y_p , the motor actuator can be monitored for functional troubles. With these controllers (Cfunc = 08, 09, 12), the actuator function is monitored completely. Monitoring is possible for:

- defective motor
- faulty phase sequence,
- defective motor capacitor (faulty rotary direction),
- defective power transmission to spindle or gearing,
- excessive backlash due to wear,
- jammed control valve due to e.g. foreign bodies.

The function can be enabled via parameter DAC® :

DAC 0 : no DAC
 1 : DAC function checking

Description

Unless correct Y_p change detection is possible despite the output of closing or opening pulses, there is a trouble. The trouble is displayed and the controller goes to manual operation, i.e. no pulses are output any more.

| Display | Signification | Possible causes |
|---------|---------------|---|
| Block | No reaction | <ul style="list-style-type: none"> • blocking • Cable break |
| DirEr | No reaction | <ul style="list-style-type: none"> • Defective motor • capacitorPhase error • Wrong polarity • Controller output action error (E 100) |
| YFail | Y_p Error | <ul style="list-style-type: none"> • Potentiometer defective or not connected |

Signalling

For detected actuator error signalling, a limit relay can be switched.

C600, C620, C640 and C660 were extended by Src=24 / actuator error

Positioning value limiting

As already provided with the present KS 92/94 version, Y_p monitoring for Y_{min} and Y_{max} remains available. When exceeding these limits, no further pulses in the relevant direction are output. The DAC® function ensures that no limits are exceeded even in case of one or several actuator or potentiometer errors. Due to the measurement cycle, however, limit exceeding by a very low value dependent of actuator speed and inertia cannot be prevented.

Reset after actuator error

With actuator error detection, the controller switches to "manual mode" and displays the error:

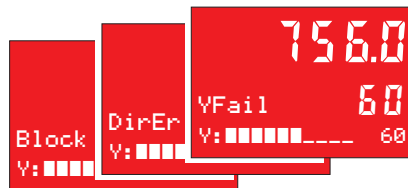

When the plant trouble was removed, the operator must inform the controller accordingly. For this, press key or and/or switch the controller to "automatic mode". If the actuator error continues, the controller detects it and switches off again. In any case, the controller must be switched back to automatic mode by the operator!

Operating limits

3-point stepping controller with position feedback or continuous controller with position control

- The Yp change must be higher than 2 Ω /sec or 0,1 mA/sec! Example: motor actuator with travel time Tm = 60sec → resistance change R 120 Ω
- Conductive plastics potentiometers must be used, because their reliability and linearity is much better than with wire potentiometers.
- Any change of the motor actuator movement must cause a potentiometer resistance change.
- Drives with a high backlash are detected as defective.

Continuous controllers with position feedback

- The position fed back may have a maximum deviation of 10% after filtering with T = 20sec.

Automatic Yp – calibration

To facilitate operation, the automatic Yp calibration was introduced. The controller changes its output to determine the two end positions and actuator travel time Tm.

- Start:
- During manual operation, select parameter **YpCal** and set it to 1.

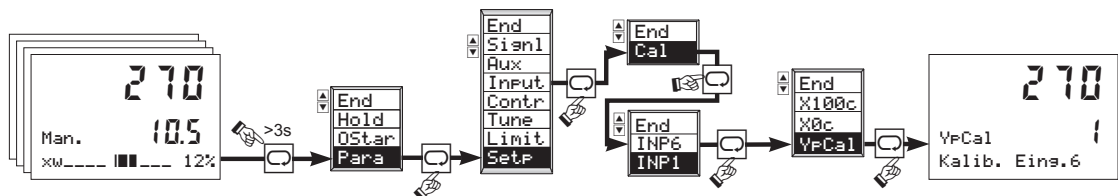

• **Procedure:**

Y1 is activated, until no changes are measured any more via Yp. The measurement value is stored as **x0c**. Subsequently, Y2 is activated, until Yp does not change any more. This measured value is stored as **x100c**. The duration of adjustment from 0 to 100% is measured and stored as Tm. Like **x0c** and **x100c**, **YpCal** can be marked for the extended operating level.

| Display | signification | Possible causes |
|---------|-------------------|--|
| | Calibration error | <ul style="list-style-type: none"> • Potentiometer too small • Not connected • Potentiometer polarity error |

• **Operating limits:**

The motor actuator must be able to withstand a short-term (3-4sec) operation close to its limits without damage! Otherwise, the operating limits specified for DAC are applicable (see above).

10 Alarm processing

Up to four alarms can be configured. These alarms are allocated to the individual outputs. Generally, each of the outputs OUT1, OUT2, OUT4, OUT5 (unless used by other signals) can be used for limit value or alarm signalling.

Each of the 4 limit values LIM1 ... LIM4 has 2 trigger points **LimH** (Max) and **LimL** (Min), which can be switched off individually (parameter "----"). The switching difference **Lxsd** of each trigger point is adjustable.

Fig.: 46 operating principle of relative limit contact **LimH** / **LimL**

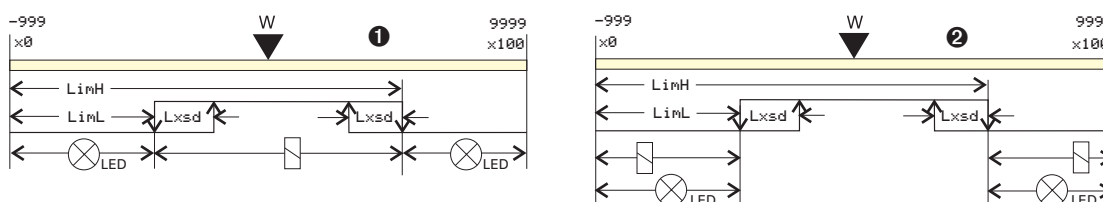

① normally closed, ② normally open (selection in **£.500 ff; mode**). **LimL** and **LimH** correspond to values (**£.600 ff; Src**), at which there will be an alarm. .

Fig.: 47 operating principle of relative limit contact **LimH** / **LimL**

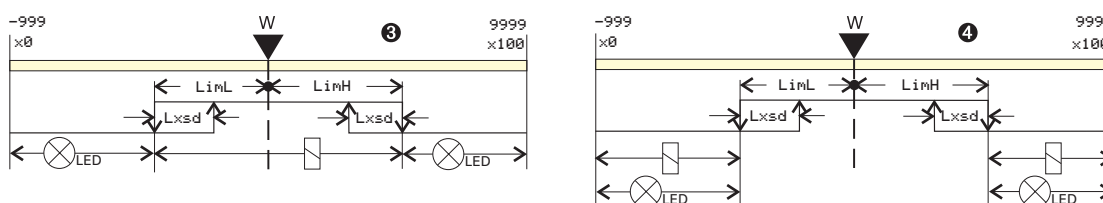

③ normally closed, ④ normally open (selection in **£.500 ff; Mode**). **LimL** and **LimH** correspond to control deviations which cause the alarm.



Limit values below the set-point must be specified with negative polarity sign.

The variable to be monitored can be selected separately for each alarm via configuration:
The following variables are available:

- effective process value (Limit contact)
 - control deviation (Limit comparator)
 - process value x1
 - process value x2
 - process value x3
- } Input + eventually signal pre-processing (**Func1/2** → page 26 a. 63)
- auxiliary variable z
 - external set-point w_e
 - external set-point offset $d w_e$
 - effective set-point w_{eff}
 - position feedback Y_p
 - controller output
 - override control OVC
 - selectable set-point input W_{Sel}
 - pre-processed process value inputs INP1 ... INP6 (after input conditioning → page 26 a. 63)
 - net program time
 - gross program time
 - program rest time

The alarm function is also configurable:

- switched off
- sensor monitoring: signalling with sensor error of the selected signal source
- sensor monitoring / measurement value alarm:
- sensor monitoring / measurement value alarm with suppression after set-point change and start-up
- Measuring value alarm
- Measuring value alarm with suppression after set-point change and start-up

10.1 Alarm 1 / (limit 1)

The function of this alarm is determined in configuration parameter **£.500**.

Alarm signalling is via output OUT4, if this was determined as **Src = 29** in the configuration **£.590**.

10.2 Alarm 2 / (limit 2)

The function of this alarm is determined in configuration parameter **£.520**.

Alarm signalling is via output OUT5, if this was determined as **Src = 25** during configuration **£.591**.

10.3 Alarm 3 / (limit 3)

The function of this alarm is determined in configuration parameter **£.500**.

Alarm signalling is via output OUT1, if this was determined as **Src = 27** by configuring **£.500**.

10.4 Alarm 4 / (limit 4)

The function of this alarm is determined in configuration parameter **£.500**.

Alarm signalling is via output OUT2, if **Src = 28** was determined by configuring **£.530**.

11 Optimizing the controller

11.1 Process characteristics

In order to tune the controller to the process, the process characteristics must be determined. During self-tuning, these process data are determined automatically by the controller and converted into control parameters. In exceptional cases, however, manual determination of these process data may be necessary. For this, the response of process variable x after a step change of correcting variable y can be used (see Fig. 48). Usually, it is not possible to plot the complete response curve (0 to 100 %), as the process must be kept within certain limits.

The maximum rate of increase v_{max} can be determined from the values T_g and x_{max} (step from 0 to 100 %) or t and x (partial step response).

Fig.: 48 Step response of process

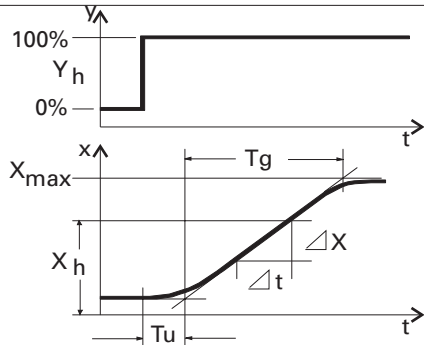

- y = correcting variable
- Y_h = control range
- T_u = delay time (s)
- T_g = recovery time (s)
- $V_{max} = X_{max} / T_g = \Delta x / \Delta t = \text{max. rate of increase of process value}$
- X_{max} = maximum process value
- X_h = adjustment range of controller $\times 100 - x_0$

$$K = \frac{V_{max}}{X_h} \cdot T_u \cdot 100\%$$

11.2 Controller characteristics

The control parameters can be determined from the values calculated for delay time T_u , max. rate of increase v_{max} , control range X_h and characteristic value K according to the formulas given below. Precise adjustment should be done as specified in the table. Increase X_p , if line-out to the set-point oscillates.

| General formulas | | | | Reference values | | | |
|---------------------------------|-----------|----------|-----------------|------------------|------------------|-------------------|---------------------------------|
| Behavior | $X_p[\%]$ | $T_v[s]$ | $T_n[s]$ | Parameter | Control | Disturbance | Start-up behaviour |
| (D)PID | $1,7 K$ | $2 T_u$ | $2 T_u$ | X_p bigger | stronger damping | slower line-out | slower reduction of duty cycle |
| PD | $0,5 K$ | T_u | $\infty = 0000$ | smaller | reduced damping | faster line-out | faster reduction of duty cycle |
| PI | $2,6 K$ | 0 | $6 T_u$ | T_v bigger | reduced damping | stronger reaction | earlier reduction of duty cycle |
| P | K | 0 | $\infty = 0000$ | smaller | stronger damping | weaker reaction | later reduction of duty cycle |
| 3-point stepping controller PID | | | | T_n bigger | stronger damping | slower line-out | slower reduction of duty cycle |
| | $1,7 K$ | T_u | $2 T_u$ | smaller | reduced damping | faster line-out | slower reduction of duty cycle |

The various control functions are adjustable with configuration parameter $\text{C.100}; \text{CFunc.}$

Direct / inverse switch-over is always possible according to configuration $\text{C.101}; \text{CMode.}$ The principle is shown in Fig.: 49.

Fig.: 49 Direct / inverse switch-over principle

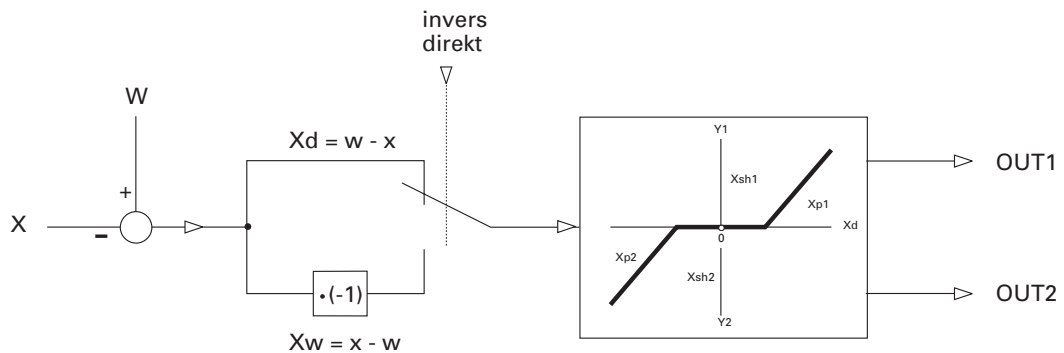

11.2.1 Signallers

This configuration can be used for processes with small T_u and slow v_{\max} . Control oscillations are determined by :

$$X_0 = x_{\max} \cdot \frac{T_u}{T_g} + X_{Sd} = v_{\max} \cdot T_u + X_{Sd}$$

The signal function corresponds to limit signalling, whereby the set-point is the limit value. The trigger point is symmetrical on both sides of the set-point; hysteresis X_{sd1} is adjustable.

The signaller with two outputs has an additional “pre-trigger point”. The separation between this point and the set-point is adjustable using parameter LW (including polarity).

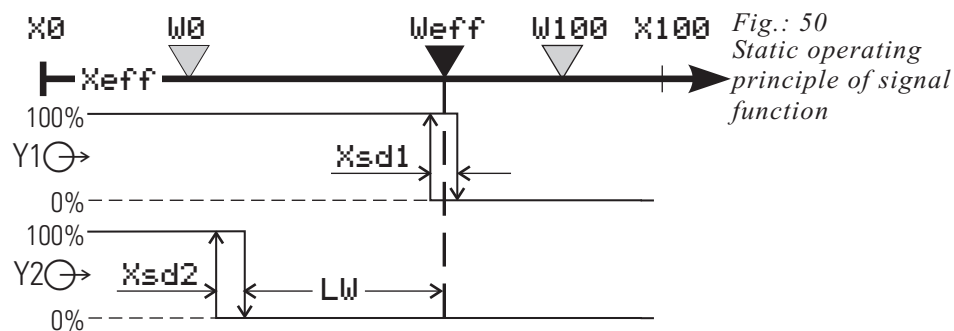

As no manual function is possible with a signaller, calibration (resistance transducer) is only possible by configuration changing e.g. for two-point controller.

| Configuration | Effective controller parameters | | |
|---|---------------------------------|--|---------------|
| C. 100; CFunc = 00 (signaller with 1 output) 01 (signaller with 2 outputs) | Xsd1 | Signaller switching difference | 0,1 ... 999,9 |
| | LW | Trigger point separation of additional contact | -999 ... 9999 |
| | Xsd2 | Switching difference of additional contact | 0,1 ... 999,9 |

11.2.2 Two-point controller

Cycle time T_1 must be adjusted at configuration level.

It corresponds to the minimum cycle time with 50 % duty cycle.

For optimizing according to the control response, the hints given in Fig. 3 must be followed.

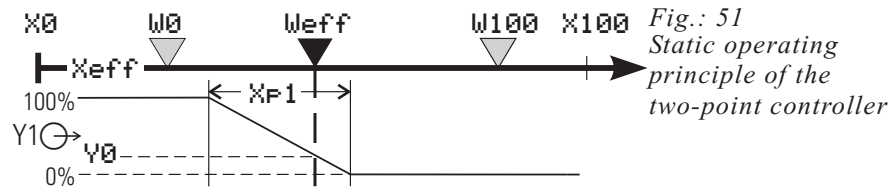

PD behaviour ($T_n = \infty$)

The working point is in the centre of proportional band X_{p1} at 50 % duty cycle. For keeping the process constant, a certain amount of energy dependent of the set-point is necessary. This results in a permanent control deviation, which will increase with higher values for X_{p1} .

DPID behaviour

By means of the integral action, the process is lined out without permanent offset.

The static characteristic of a two-point controller is identical with the one of the continuous controller. The difference is that a duty cycle is output instead of a linearly variable current signal (relay contact, 0/20mA logic signal or 0/24V control output).

Working point Y_0 and cycle time T_1 at 50% duty cycle are adjustable. The shortest step is 100ms.

| Configuration | Effective controller parameters | | |
|---|---------------------------------|--------------------------------------|-------------------|
| C. 100; CFunc = 02 (two-point controller) | Y2 | Additional correcting variable | -105 ... 105 [%] |
| | Ymin | min. correcting variable limiting | -105 ... 105 [%] |
| | Ymax | max. correcting variable limiting | -105 ... 105 [%] |
| | Y0 | working point of correcting variable | -105 ... 105 [%] |
| | Xp1 | proportional band 1 | 0,1 ... 999,9 [%] |
| | Tn1 | integral action time | 0 ... 9999 [s] |
| | Tv1 | derivative action time | 0 ... 9999 [s] |
| | T1 | switching period | 0,4 ... 999,9 [s] |

11.2.3 Three-point controller

Adjust cycle times T_1 and T_2 at configuration level. They correspond to the minimum cycle times at 50 % duty cycle.

For optimizing according to the control response, the hints given in Fig. 3 must be followed.

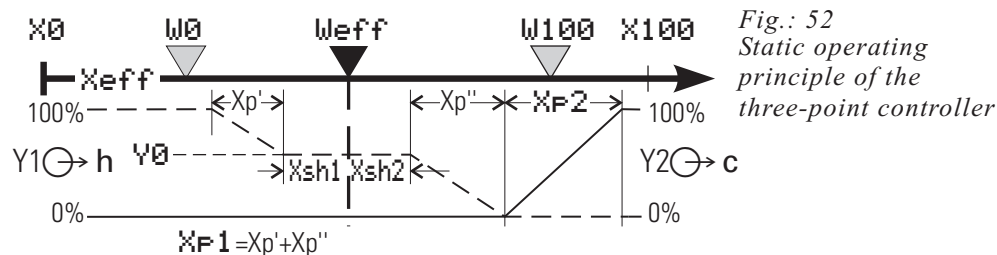

PD/PD behaviour ($T_n = \dots$)

The adjustment range reaches from 100 % heating (Y1) to 100 % cooling (Y2).

The proportional bands must be matched to the different heating and cooling rates. For keeping the process lined out, a certain amount of energy dependent of set-point is necessary. This results in a permanent offset, which will increase with higher $X_{p(1,2)}$.

DPID/DPID behaviour

By means of the integral action, the process is lined out without permanent offset.

The transition from trigger point 1 (heating) to trigger point 2 (cooling) is without neutral zone. The proportional bands must be matched to the different heating and cooling rates (Fig. 4).

The drawings in Fig.:52 show the static characteristic for inverse and direct action. Direct/inverse switch-over only causes the exchange of the outputs for “heating/cooling”. The terms “heating” and “cooling” are used for all similar processes (batching acid/lye, ...). The neutral zone is adjustable separately for the trigger points (X_{sh1} , X_{sh2}), i.e. it need not be symmetrical on both sides of the set-point.

The type of positioning signals is selectable:

- heating switching, cooling switching
- heating continuous, cooling switching
- heating switching, cooling continuous

Combination “heating continuous” and “cooling continuous” is covered by “continuous split range”.

With inverse controller output action, “heating” is allocated to output OUT1 and “cooling” is allocated to output OUT2. As the controller versions provide only OUT1 with current signal, “heating switching; cooling continuous” seems to be possible only via OUT3 (option C). With “direct” action, however, cooling is allocated to OUT1 and heating is allocated to OUT2, so that option C is not indispensable.

| Configuration | effective controller parameters | | |
|--|---------------------------------|--------------------------------------|-------------------|
| 1. 100; CFunc = 03 (three-point controller Heating /cooling switching) 04 (three-point controller heating continuous cooling switching) 05 (three-point controller heating switching cooling continuous) | Xsh1 | neutral zone ($X_w > 0$) | 0,0 ... 999,9 [%] |
| | Xsh2 | neutral zone ($X_w < 0$) | 0,0 ... 999,9 [%] |
| | Y2 | additional correcting variable | -105 ... 105 [%] |
| | Ymin | min. correcting variable limiting | -105 ... 105 [%] |
| | Ymax | max. correcting variable limiting | -105 ... 105 [%] |
| | Y0 | working point of correcting variable | -105 ... 105 [%] |
| | XP1 | proportional band 1 | 0,1 ... 999,9 [%] |
| | XP2 | proportional band 2 | 0,1 ... 999,9 [%] |
| | Tn1 | integral action time | 0 ... 9999 [s] |
| | Tv1 | derivative action time | 0 ... 9999 [s] |
| T1 | cycle time 1 | 0,4 ... 999,9 [s] | |
| T2 | cycle time 2 | 0,4 ... 999,9 [s] | |

11.2.4 $\Delta/Y/off$

The principle is identical with the control behaviour of a signal function with additional contact. Output OUT2 is used for switching over between “ Δ ” and “Y”. Output OUT1 switches the heating power on and off.

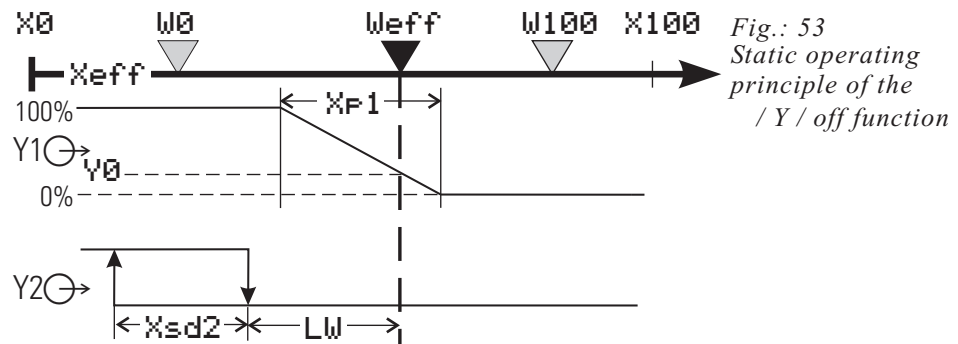

| Configuration | Effective controller parameters | | |
|--|---------------------------------|--|-------------------|
| L. 100; CFunc = 06 (/Y/off function) | LW | trigger point separation of additional contact | -999 ... 9999 |
| | Xsd2 | signaller switching difference | 0,1 ... 999,9 |
| | Y2 | additional correcting variable | -105 ... 105 [%] |
| | Ymin | min. correcting variable limiting | -105 ... 105 [%] |
| | Ymax | max. correcting variable limiting | -105 ... 105 [%] |
| | XP1 | proportional band1 | 0,1 ... 999,9 [%] |
| | Tn1 | integral action time | 0 ... 9999 [s] |
| | Tv1 | derivative action time | 0 ... 9999 [s] |
| | T1 | cycle time 1 | 0,4 ... 999,9 [s] |

11.2.5 Three point stepping controller

In order to match the adjusted X_{p1} to the motor actuator travel time, the travel time T_m must be adjusted. The smallest positioning step of the controller is 80ms. Dependent of configuration (E.191; SPI/P), the feedback can be switched off.

Adjusting the neutral zone

The neutral zone X_{sh} can be increased with excessively frequent relay switching. Note, however, that an increased neutral zone will cause a decrease of the control sensitivity.

Therefore, we recommend to optimize switching frequency (wear of motor actuator) and control sensitivity.

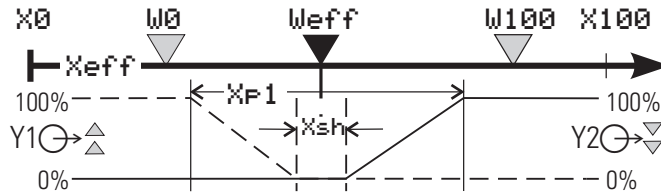

Fig.: 54 Static operating principle of the three-point stepping controller

Three-point stepping controllers can be operated with or without position feedback Y_p .

Y_p is not required for operation. Fig.: 54 show the static characteristics of the three-point stepping controller with inverse and direct configuration.

The hysteresis shown in this diagram is practically negligible, however, it can be calculated from the adjustable min. pulse length $T_{pulse} \geq 100ms$.

$$X_{sh} = \frac{T_{puls}}{2} \cdot 0,1 \cdot \frac{X_p}{T_m}$$

- With **Tpuls** switched off, the shortest positioning step **Tpuls'** is dependent of **Tm**, **Xsh** and **Xp**. By variation of **Xsh**, the required min. pulse length **Tpuls'** can be reached:

$$X_{sh} = 12,5 \cdot X_p \cdot \frac{T_{puls'}}{T_m} - 0,75$$

Correcting variable limit with three-point stepping controllers

With 3-point stepping controller with position feedback, the output is limited to y_{min} and y_{max} . Checking if the Y_p value is higher than y_{max} or lower than y_{min} is done exclusively. If this is the case, further closing or opening pulses are suppressed. Due to the actuator inertia and measurement of potentiometer via INP6 (800ms), the limits may be exceeded insignificantly.

| Configuration | Effective controller parameters | | |
|--|---------------------------------|-----------------------------------|-------------------|
| E.100; CFunc = 07 (Three-point stepping controller without feedback) 08 (Three-point stepping controller with feedback) | Xsh | neutral zone | 0,2 ... 999,9 [%] |
| | Tpuls | Min. pulse length | 0,1 ... 2,0 [s] |
| | Tm | Actuator travel time | 10 ... 9999 [s] |
| | Y2 | additional correcting variable | -105 ... 105 [%] |
| | Ymin | min. correcting variable limiting | -105 ... 105 [%] |
| | Ymax | max. correcting variable limiting | -105 ... 105 [%] |
| | Xp1 | proportional band 1 | 0,1 ... 999,9 [%] |
| | Tn1 | integral action time | 0 ... 9999 [s] |
| | Tv1 | derivative action time | 0 ... 9999 [s] |

11.2.6 Continuous controller

The static characteristic corresponds to the one of the already described two-point controller. The continuous controller in split-range operation is comparable to the three-point controller. The neutral zone can also be adjusted separately.

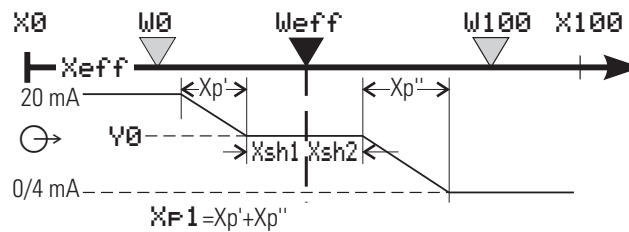

Fig.: 55
Static operating
principle of
continuous controller

With a continuous controller with position feedback, the actually flowing positioning current can be measured and displayed via INP6. Y_p is not used either.

Maximum and minimum output current are adjustable:

-y = 0...100 % (min. current)

+y ≥ -y + 10 % (max. current)

The working point is adjustable $y_0 = 0..100$ %.

In order to operate the instrument as a P or PD controller, $T_n =$ can be set by means of contact FB or by setting $T_n = 0$. For optimizing according to the control response, the hints given in Fig. 8 must be followed.



With contact FB closed, manual → automatic and automatic → manual switch-over is bumpless! Transition to the new correcting variable is with the adjusted integral action time T_n .

| Configuration | Effective controller parameters | | |
|---|---------------------------------|-----------------------------------|-------------------|
| [. 100 ; CFunc = 10 (continuous controller) 11 (continuous controller Split range) 12 (continuous controller with Y_p feedback) | Xsh1 | neutral zone ($X_w > 0$) | 0,0 ... 999,9 [%] |
| | Xsh2 | neutral zone ($X_w < 0$) | 0,0 ... 999,9 [%] |
| | Y2 | additional correcting variable | -105 ... 105 [%] |
| | Ymin | min. correcting variable limiting | -105 ... 105 [%] |
| | Ymax | max. correcting variable limiting | -105 ... 105 [%] |
| | XP1 | proportional band 1 | 0,1 ... 999,9 [%] |
| | XP2 | proportional band 2 | 0,1 ... 999,9 [%] |
| | Tn1 | integral action time | 0 ... 9999 [s] |
| Tv1 | derivative action time | 0 ... 9999 [s] | |

11.2.7 Continuous controller with position control

This is basically a cascade. A tracking controller with three-point stepping behaviour which operates with Y_p as process value (INP6) is used with the continuous controller. The advantages of this combination are in the availability of all functions which are possible with continuous controllers, such as

- working point adjustment
- adjustable correcting variable limits
- override control
- use of a disturbance at the positioning output
- *Switch-over to a second correcting value Y_2*

The disadvantage might be that the control availability depends on the Y_p potentiometer, which is subject to wear. This fact is taken into account by automatic switch-over to three-point stepping control without position feed-back in case of potentiometer error.

Fig.: 56 Continuous controller with position controller

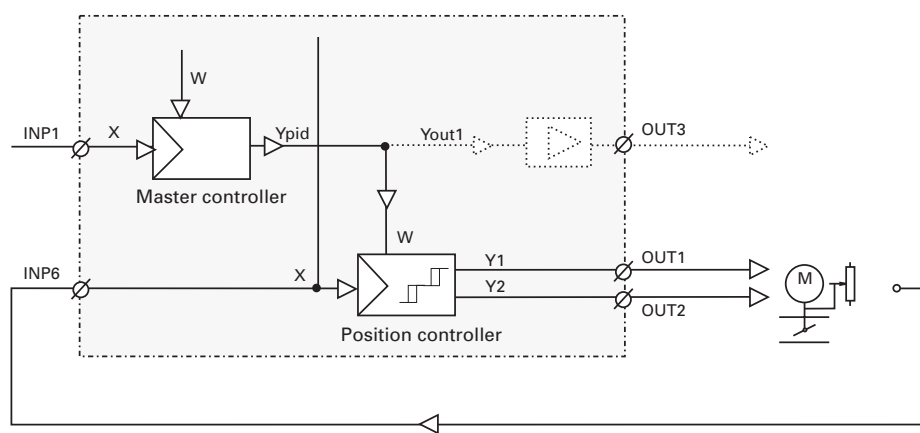

| Configuration | Effective controller parameters | | |
|---|---------------------------------|-----------------------------------|-------------------|
| C. 100; CFunc = 09 (continuous controller with position controller) | Tpuls | min. pulse length | 0,1 ... 999,9 [s] |
| | Tm | actuator travel time | 10 ... 9999 [s] |
| | Xsh1 | neutral zone ($X_w > 0$) | 0,0 ... 999,9 [%] |
| | Xsh2 | neutral zone ($X_w < 0$) | 0,0 ... 999,9 [%] |
| | Y2 | additional correcting variable | -105 ... 105 [%] |
| | Ymin | min. correcting variable limiting | -105 ... 105 [%] |
| | Ymax | max. correcting variable limiting | -105 ... 105 [%] |
| | Xp1 | proportional band 1 | 0,1 ... 999,9 [%] |
| | Tn1 | integral action time | 0 ... 9999 [s] |
| | Tv1 | derivative action time | 0 ... 9999 [s] |

12 Optimizing the controller

12.1 Self-tuning

For determination of the optimum process parameters, self-tuning is possible. Self-tuning can be started and finished via the system menu during automatic or manual mode.



Moreover, self-tuning can always be cancelled by pressing the manual/automatic key  on the controller front.

Self-tuning preparations:

- Control behaviour PID, PI, PD or P can be selected by the user by switching off $T_n=0$ or $T_v=0$ before self-tuning start.
- Determine which parameter set must be optimized (P_{Opt}).
- Determine the stable correcting variable (Y_{Opt}).
- Determine the set-point step (dY_{Opt}).
- Determine the 'process-at-rest' mode $\{C.100(OCond)\}$.

12.1.1 Process-at-rest monitoring:

Process-at-rest monitoring is at any time. The process is at rest with the process value within a tolerance band of $\pm\Delta X = 0.5\%$ during more than 60 seconds. When the monitored variable leaves this tolerance, the monitoring time counter is reset to zero. With e.g. PiR detected during control operation and output of a widely varying stable correcting variable Y_{Opt} when starting the self-tuning, waiting until the full PiR time has elapsed is necessary.

With extended PiR monitoring, monitoring is done for a regularly varying instead of a constant process variable !

Configuration word **C.100 (OCond)** can be used to determine the mode of 'process-at-rest' detection. One of the following modes can be selected:

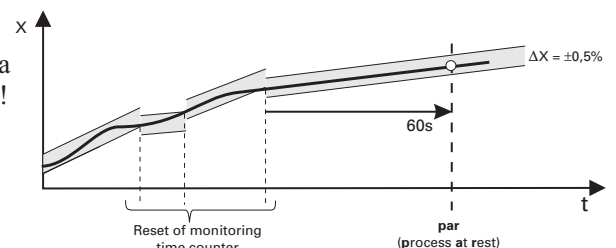
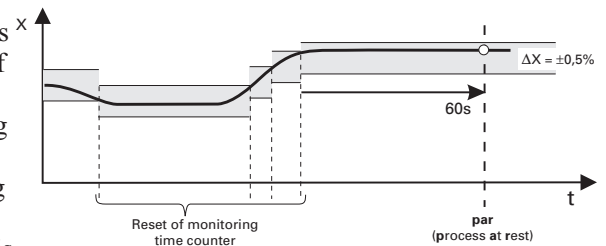

| | |
|---|---|
| $\text{grad}(x) = 0$: | Process at rest is detected, when x is constant. |
| $\text{grad}(x) \leq 0 = \text{const \& inverse}$: | Process at rest is detected, when x decreases regularly with a controller with inverse action. |
| $\text{grad}(x) \geq 0 = \text{const \& direct}$: | Process at rest is detected, when x increases regularly with a controller with direct action. |
| $\text{grad}(x) \neq 0$: | Process at rest is detected, when x varies regularly. In this case, continuation of this constant change as long as identification lasts must be ensured. |

12.1.2 Set-point reserve:

As a pre-requisite for realization of the self-tuning procedure, the separation of set-point and process value must be higher than 10% of $W_0 \dots W_{100}$ before output of the correcting variable step! The set-point reserve is realized either automatically by reduction of the correcting variable during the PiR phase or by manual set-point or process value changing (manual mode).

12.1.3 Start during automatic operation:

After self-tuning start, stable correcting variable Y_{OPT} is output. After detection of 'process at rest' (PiR), the correcting variable step dY_{OPT} is output and the parameter determination procedure is realized. The set-point can always be changed, whereby the gradient function for set-point adjustment is switched off.

Fig.: 57 Self-tuning [$grad(x)=0$]

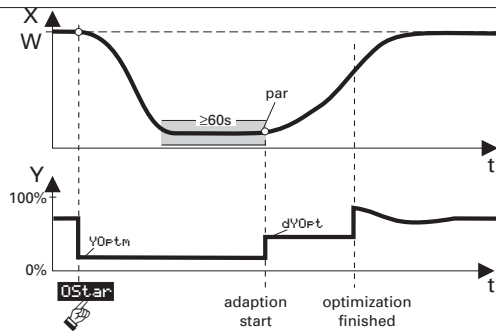
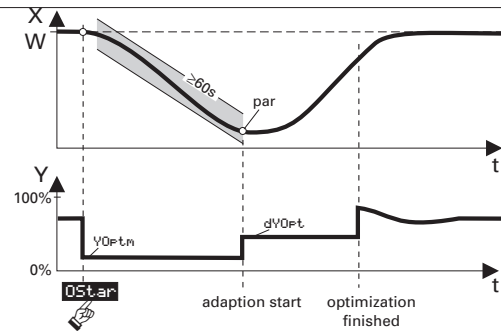

Fig.: 58 Self-tuning [$grad(x)<0$]



12.1.4 Start during manual operation



Self-tuning start during manual operation can be done only, if the controller was switched to manual mode via its front panel or via the interface.

During switch-over to manual operation, the correcting variable output last is stored as manual correcting variable. When starting the self-tuning, this correcting variable is used and output as temporary stable correcting variable. After reaching PiR, the optimization is started. Pre-requisite for optimization start is a sufficient set-point reserve (\rightarrow page 73).

'Process at Rest' (PiR) can be reached already when starting, i.e. the waiting time is omitted. As during automatic mode, the set-point can always be adjusted.

Fig.: 59 Start by increasing the setpoint

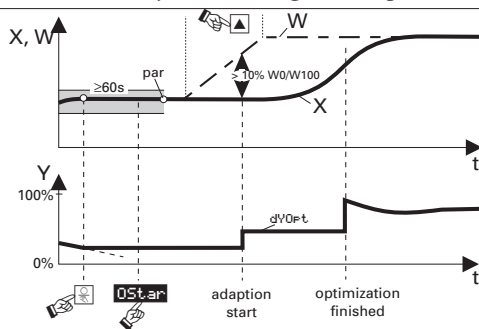
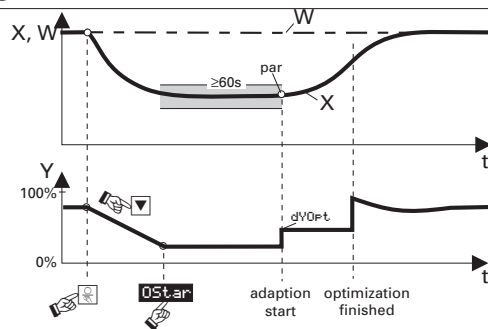



Fig.: 60



After successful self-tuning, switch-over to automatic mode is automatic. The process characteristics are available as parameters $Tu1, Vmax1$. The parameters for the required control behaviour are determined on the basis of these characteristics.



If self-tuning is finished with an error (Ada_F), the stable correcting variable is output, until self-tuning is finished by the user via the system menu, front panel key  or via the interface.

12.1.5 Self-tuning procedure with heating:

(2-point, 3-point stepping, continuous controller)

After reaching 'process at rest', the process is started with a correcting variable step and $Tu1$ and $Vmax1$ are determined from the process reaction, if possible, at the reversal point of the step response.

12.1.6 Self-tuning procedure with heating and cooling processes:

(3-point / split-range operation)

Self-tuning starts as with a "heating" process. After the self-tuning end, the controller is determined from the calculated parameters. These parameters are used for lining out to the pre-defined set-point, until PiR is reached again. For determining the "cooling" parameters, a set-point step is output, in order to determine $Tu2$ and $Vmax2$ using the step response. Based on these parameters, the parameters for split-range operation are also determined for cooling. When cancelling the cooling attempt, the parameters for 'heating' are also used for 'cooling'. Error (Hda_F) signalling is omitted.

Fig.: 61

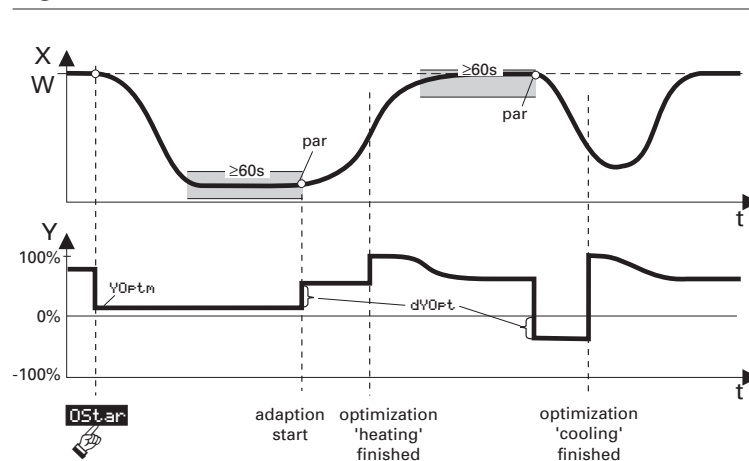

- i When starting the optimization with a three-point stepping controller, the correcting variable is always reduced completely and Y_{OptM} is output, if the instantaneously effective correcting variable y_p cannot be measured.
- i For keeping the process within safe limits, the set-point is monitored continuously for out-of-limits.
- ! Whilst self-tuning is running, the override control function is switched off! I.e.: Y_{pid} is within the limits for Y_{min} and Y_{max} .
- ! With controllers, self-tuning is withfunction, i.e. $Y2 = 0$.

12.1.7 Signification of self-tuning messages MSG1/MSG2

| MSG1/2 | Signification or error cause | Possible solution |
|--------|---|---|
| 0 | No attempt was made or attempt cancelled by switching over to automatic. | |
| 1 | Cancellation: Wrong action of correcting variable, X does not change towards W. | Change controller output action. |
| 2 | Finished: Self-tuning was successful (reversal point found; safe estimation) | |
| 3 | Cancellation: The process does not react or reacts too slowly (change of ΔX below 1% during 1 hour) | |
| 4 | Finished : (low reversal point) Cancellation: Stimulation insufficient (reversal point found; unsafe estimation) | Increase set-point step ΔW_{Opt} . |
| 5 | Cancellation: Optimization cancelled due to exceeded set-point risk. | Increase separation of process value (X) and set-point (W) during start-up. |
| 6 | Finished: Optimization cancelled due to exceeded set-point risk (reversal point not reached so far; safe estimation). | |
| 7 | Cancellation: Insufficient output step, $\Delta Y < 5\%$. | Increase Y_{max} or reduce $Y_{Opt,m}$. |
| 8 | Cancellation: Set-point reserve insufficient or set-point exceeded during PiR monitoring | Change stable correcting variable $Y_{Opt,m}$. |



Unless control is functioning properly as required despite self-tuning, proceed additionally as described in section 12.2 (page 9, Optimizing empirically). Moreover, the specifications on further parameters must be taken into account.

12.2 Optimizing empirically



If process data are missing, empirical optimization by means of self-tuning or by manual attempts is possible. When attempting empirical optimization, the following information should be taken into account:

- Ensure that correcting variable and control variable will never reach inadmissible values!!!
- In order to have comparable results, the conditions for the attempts should be always identical.
- The attempt procedure must be oriented at the target of optimization: control behaviour or disturbance behaviour.
- The controller working point must be equal with the attempts.

When using the control parameters for the first time, they must be adjusted as follows:

- X_p as high as possible: to the highest adjustable value,
- T_v relatively high: max. the time needed by the process until a clear process reaction starts.
- T_n high: max. the time needed by the process for the overall reaction.

The time requirement for empirical optimization is rather high. In order to have a reasonable result within a relatively short period of time, we recommend proceeding as described below:

- ① Adjust $T_n=T_v=0$ and X_p as high as possible (P controller). Reduce X_p from attempt to attempt, as long as control is sufficiently stable. If control becomes too unstable, increase X_p slightly and continue with ②.
 - ② Measure the permanent control deviation: If it is sufficiently low, self-tuning is **finished successfully (P)**. If it is too high, PD control is better for the process (adjust a relatively high T_v and continue with ③).
 - ③ Reduce X_p from one attempt to the next one, as long as control is sufficiently stable. If control gets too unstable, continue with ④.
 - ④ Reduce T_v and find out if control can be re-stabilized sufficiently. If this is the case, continue with ③, otherwise increase X_p slightly and continue with ⑤.
 - ⑤ Find out if X_p was reduced considerably during procedures ③ and ④. If this is the case, continue with ⑥, otherwise PI control is recommendable for the process (set T_v to 0 and continue with ⑦).
 - ⑥ Measure the permanent control deviation. If it is sufficiently low, self-tuning is **completed successfully (PD)**. If it is too high, PID control is preferable for the process (stop changing X_p and T_v and continue with ⑦).
 - ⑦ Adjust a high T_n value and reduce it as long as control is sufficiently stable. If control gets too instable, increase X_p slightly, and self-tuning is **completed successfully (PID or PI)**.
-  Empirical optimization is improved considerably by using a recorder (or engineering tool trend function) for control variable (process value X) related to time requirement and quality and evaluation of the test results is facilitated significantly.
-  The method described above can be generalized only with restrictions and does not lead to a clear improvement of the control behaviour with all processes.
-  Changing working point (Y_0), trigger point separation (X_{sh}) and cycle times (T_{p1} and T_{p2}) leads to results which may or may not be satisfactory. With 3-point stepping controllers, T_m must be set to the real travel time of the connected motor actuator.

12.3 Selectable adaptation (only KS94)

For certain applications, matching the control parameter set to the actual process status may be reasonable. For this, KS94 is provided with max. 4 control parameter sets, which can be selected via various signals. With default configuration, only one parameter set is available ($L.100; OContr = 0$).

With $OContr = 1/4/5/7$, KS 94 switches over automatically between the max. 4 parameter sets. The switch-over points are pre-determined via adjustable trigger points. Parameter $Oxsd$ determines the hysteresis for all three switch-over functions.

Fig.: 62 Switching over parameter-sets via controller signals

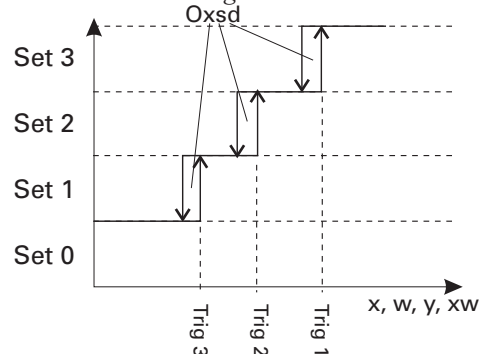

| Switch-over via | | Description | | | | |
|-----------------|---------------------------------|---|---|---|---|---|
| 0 | no function | only the actual parameter set is effective | | | | |
| 1 | control / disturbance behaviour | parameter set 0 with control behaviour, parameter set 1 with disturbance behaviour. Disturbance behaviour is detected, when the absolute value of control deviation ($ xw $) is $< Trig1$. Self-tuning can determine only parameter set 0 for control behaviour. | | | | |
| 2 | Operation | Switch-over is by changing parameter ParNr (Contr \rightarrow CPara \rightarrow ParNr). In order to reach the parameter quickly, the parameter should be at „extended operating level“! (\rightarrow section 4.4 page 20) | | | | |
| 3 | Control inputs | Switch-over is via digital inputs di8 and di9 on options card C. Which parameter set is active with which input allocation is shown in the table opposite parameter | | | | |
| | | di8 | 0 | 1 | 0 | 1 |
| | | di9 | 0 | 0 | 1 | 1 |
| | Parameter | 0 | 1 | 2 | 3 | |
| 4 | Set-point (weff) | Switch-over is at adjustable trigger points of the set-point signal (see Fig.: 62) | | | | |
| 5 | Process value (Xeff) | Switch-over is at adjustable trigger points of the process value signal (see Fig.: 62) | | | | |
| 6 | correcting variable(y) | Switch-over is at adjustable trigger points of the correcting variable (see Fig.: 62) | | | | |
| 7 | control deviation (xw) | Switch-over is at adjustable trigger points of the control deviation (see Fig.: 62) | | | | |

13 Programmer

13.1 General

13.1.1 Programmer definition

The KS9x programmer has 1 analog output and 4 control outputs (1...4) (digital).

A survey of the most important features:

- 3 programs (recipes; KS92 only 1 program!) each with ...
- 1 analog output, 4 control outputs
- 20 segments
- individual segmentation
- common preset (to “time” or “segment start”)
- common control commands (run, stop, reset)

Control outputs are not firmly coupled to the analog output segmentation. They are provided with individual segmentation, which is common for the control outputs. This means that number of segments and overall time (sum of segment times) of analog output and control output can be basically different.

Fig.: 62 Programmer definition

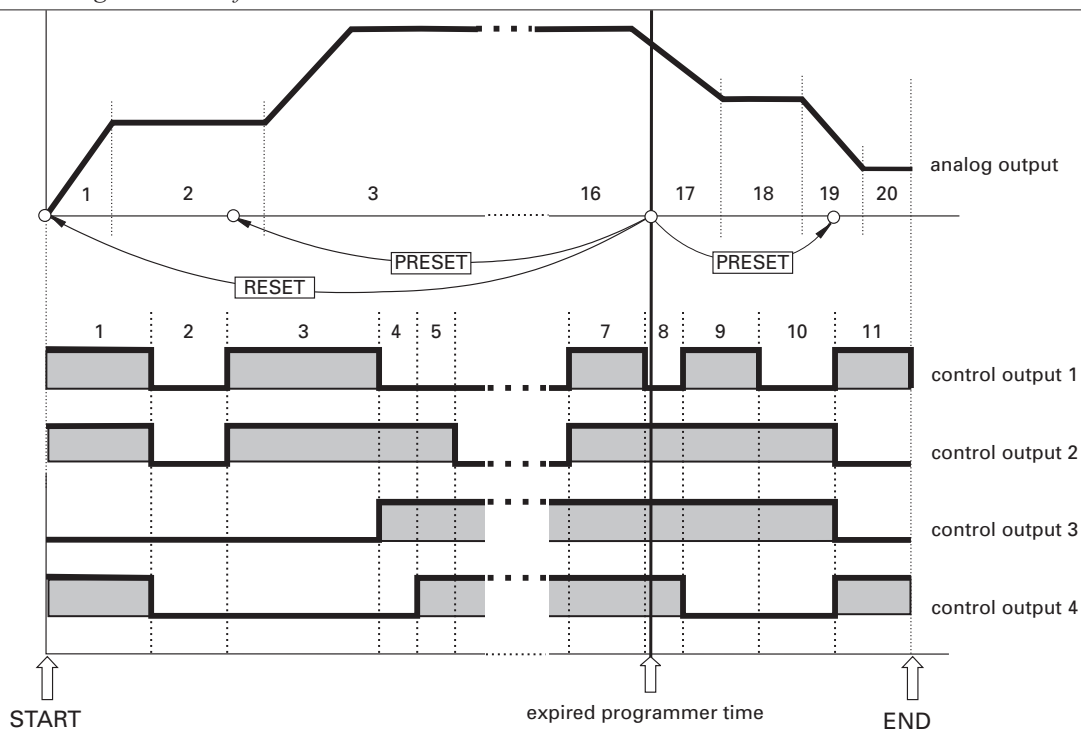

With respect to control signals and programmer visualization, the analog output is the master output. I.e. control commands act on the analog output (profile). Control outputs are forcibly tracked:

- Run/stop
- Preset and preset value (program time or segment start)
- Reset

The analog output also determines the displays:

- status (run/stop, reset, preset)
- program set-point
- actual segment no.
- elapsed times (net/gross program times; rest time)

13.1.2 Segment parameter entry

The number of segments is generally fixed to 20 for all outputs. Whether all or only part of the segments are used is determined only by the entry of segment parameters (time, value). The first segment time $T_{p_{i+1}}$ which follows on segment Seg defined last is adjusted with “----” ($\triangleq -32000$) and completes the entry sequence so that the request for entry is completed.



Entry of segment times T_{p_i} : 0 ... 9999 minutes without decimal points!

Entry sequence per recipe at parameter level (display 2):

- Change mode **Wmode** “step/ramp”
- Preset mode **Pmode** “program time/segment start”
- Number of following program **PNext**
- Bandwidth **LC-**
- Bandwidth **LC+**
- Reset value **Wp0** (analog output)
- Set-point profile
 - Set-points **Wp1 ... Wp20**
 - Segment times **Tp1 ... Tp20** [min]
- Reset value **D0** (control outputs)
- Control outputs 1...4

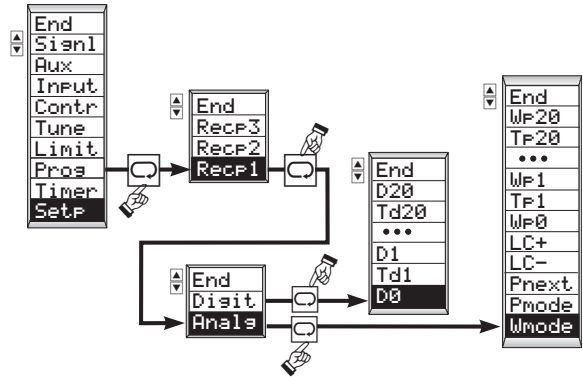

- Set-points **Dp1 ... Dp20**
The set-points of control outputs are adjusted in one adjustment procedure using the 4 decimals of display 2 (“0” = off; ”1” = on):

e.g. control output →

| | | | |
|-----|----|-----|----|
| 1 | 2 | 3 | 4 |
| 0 | 1 | 0 | 1 |
| off | on | off | on |

- Segment times **Td1 ... Td20** [min]

13.1.3 Parameter pre-setting (default)

When configuring “programmer” for the first time (**100**), all segments are at first inactive (switched off when leaving the configuration level. The programmer outputs the reset value **Wp0** (factory setting = 0) and reacts only on control commands (run, preset, ...), after the parameters of at least one segment were set. A programmer the parameters of which were already set can be switched off by configuring it accordingly. With re-activation, the previously adjusted parameters are effective again.

With start (run), the programmer starts from the instantaneous process value with the gradient of the first segment. Elapsed time and rest time are matched accordingly (cf. “search mode”, → page 86).

Fig.: 63 Search mode at first segment after program start

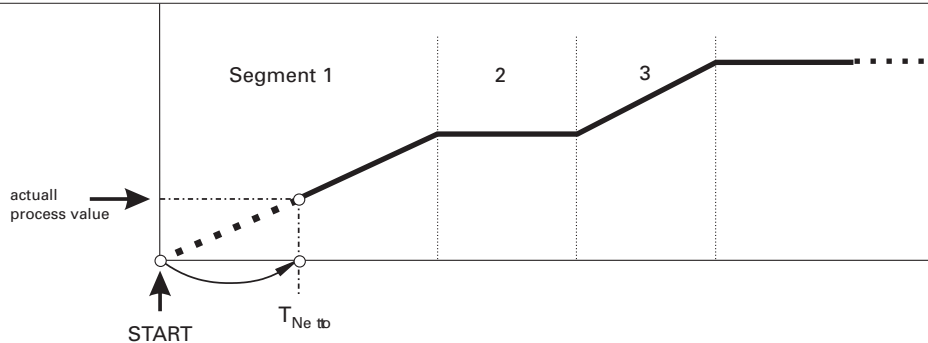

13.1.4 Time display

Segment times are adjusted and displayed in full minutes without digits behind the decimal point!

Gross, net and rest time are displayed on the front panel (display 2) in hours . minutes (extended operating level → page 88). Times above 99h.59min are rounded off and displayed in full hours; minutes are omitted. Times which refer to the past (t_{Brut} , t_{Net}), are rounded off to the next lower full hour. Times which refer to the future (t_{Rest}), are rounded off to the next higher full hour.

Rest time $t_{Rest} = 66.45 = 66 \text{ h } 45 \text{ min}$

Limit values (alarm 1...4) can act also on program time t_{Brut}/t_{Net} or on rest time t_{Rest} .

Time-related limit values are adjusted dependent of configuration (C.500 ff; DP) either
 - with four digits in full hours e.g.: 0132 = 132 h, or
 - with 2 digits and two digits behind the decimal point, e.g.: 66.75 = 66 h 45 min

Fig.: 65 Programmer time signification

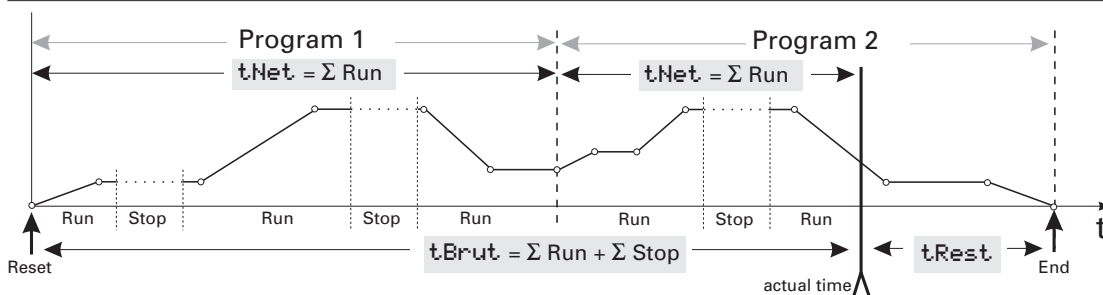

13.1.5 “Flat ramps”

The algorithm for determination of the increments with ramp-shaped change mode within a segment is designed so that low set-point changes with high set-points can be realized also with high segment time (e.g. crystal growing; from $t_i=600^\circ\text{C}$ to $t_{i+1} = 612^\circ\text{C}$ in 600h).

13.1.6 Programs (recipes)

Number of selectable programs

The required program (recipe) can be selected differently (program number PNo):

- front panel operation
- serial interface
- control inputs (di6, di7)

Due to the limited number of displays and for keeping command of the operation, KS92 is only provided with **one program** of the described length.

KS94 contains **max. 3 programs** (recipes) with 20 segments.

Fig.: 64 Recipe selection

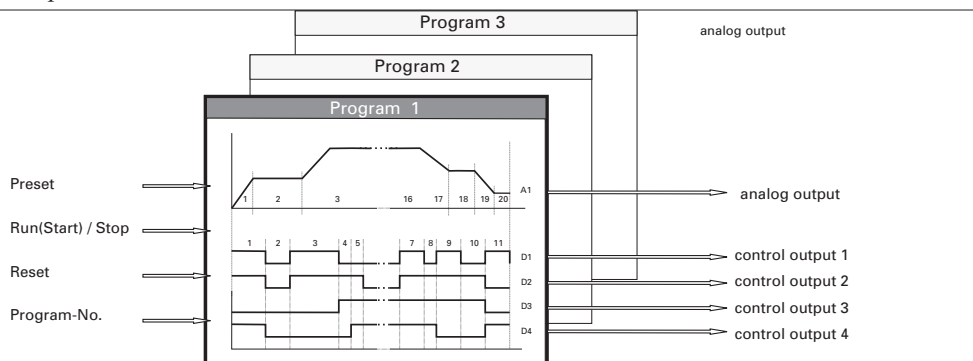

Recipe selection

Recipe selection can be done via front panel (extended operating level, “PNo”), serial interface or control inputs (configuration $\zeta. 120$). Max. 3 programs (KS94) are selectable via control inputs.

Modification of the recipe number (PNo) with already running programmer does not lead to cancellation of the instantaneous recipe. Only “reset” cancels the current recipe and leads to the start Wp0 of the new recipe.

Following program

- Automatic transition to the next process phase, or
- Waiting for enable (start signal)

The adjusted programs (recipes) can be selected manually or executed “as a sequence” automatically.

Parameter “PNext.” indicates the number of the program to be used for continuation of the operation after completion of the previous program (switched off; PNext = ‘□□’). Thus an overall process can be divided into max. three sections (process phases). In this case, the max. overall length of a program thus defined is 60 segments! Thus automatic repetition of one or several programs is also possible.

Control commands, operation and display relate exclusively to the instantaneously running, active program segment. The gross running time t.Brut. is the overall time (including pauses) from the start of the first program segment.

Fig.: 66 Following programs

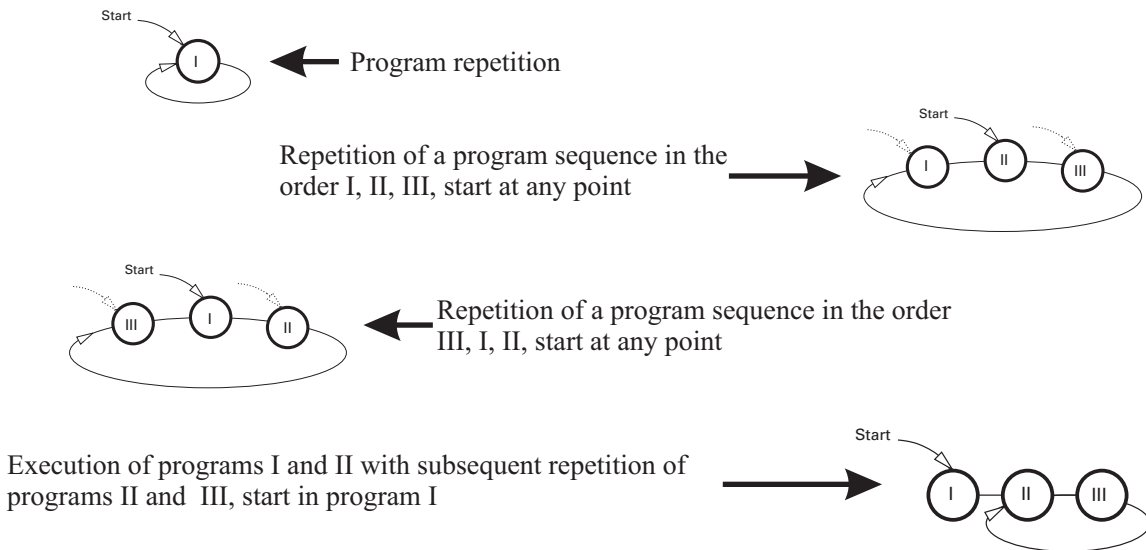
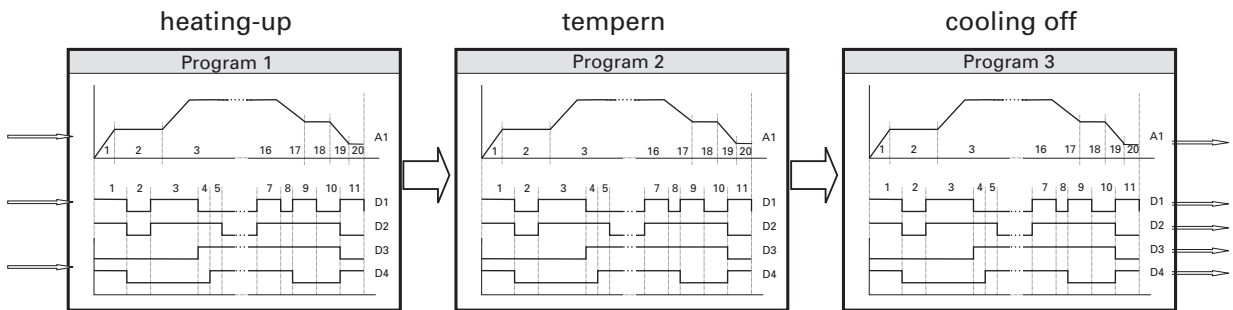

13.1.7 Change mode ramp/step

Whether the set-point (analog output) change shall be a step or a ramp is determined by a common parameter **Wmode** valid for all segments of a recipe at parameter level (default: ramp).

- **Step:**
The set-point changes to value W_{pi} immediately at the beginning of segment Seg_i and remains unchanged during segment time T_{pi} .

- **Ramp:**
The set-point changes linearly within time T_{pi} from start value Seg_i (= end value $W_{p,i-1}$ of the previous segment Seg_{i-1} ; in the first segment = process value x) to the end value of segment W_{pi} . For the first segment, the following gradient is applicable:

$$\frac{W_{p1} - W_{p0}}{T_{p1}}$$

- **Gradient priority:**

With configuration ramp with gradient priority, controller start-up is always followed by a search run, which may lead to a time reduction in the first segment. In general, the time is adapted at each search run and the gradient remains constant.

- **Time priority**

In ramp with time priority configuration, controller start-up will always be followed by a search run, which may lead to a change of the start set-point in the first segment. In general, the gradient is matched with each search run and the time remains constant.

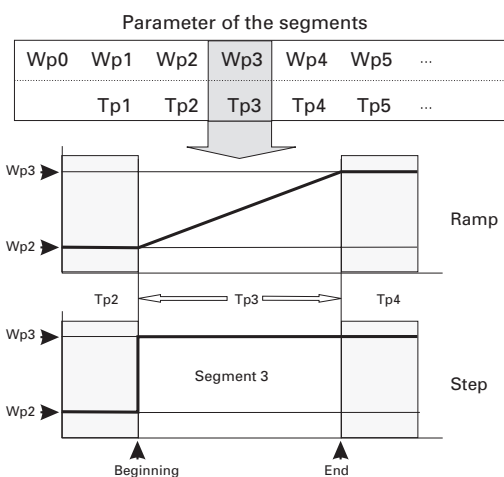

Fig.: 67 Gradient priority:

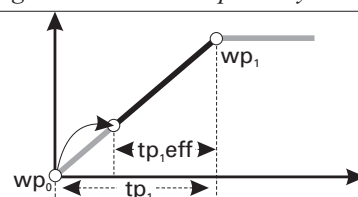
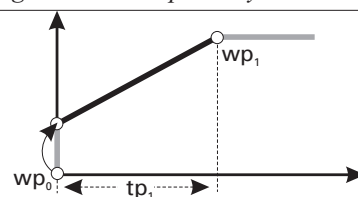

Fig.: 68 Time priority



13.1.8 Preparation for operation and end position

Each program starts with a start position W_{p0} , which is valid after resetting or setting up the programmer for the first time, until further changes are made.

With program start from the rest position, the first programmer segment starts from the instantaneous process value at the time of the start command ("ramp" with the gradients $(W_{p1} - W_{p0}) / T_{p1}$). With step change mode, the set-point of the first segment is activated immediately.

Dependent of configuration (**£. 120, PEnd**) either

- the programmer uses the set-point of the last segment until further changing (Fig.: 69) or continues automatically with the following program (if a following program was entered in "PNext"), or
- goes to rest position W_{p0} (Fig.: 70) or starting position of the following program (if a following program was entered in "PNext") at program end. The program can be started either by Run (activation or de-activation of the control input or via front panel operation) or Preset.

Reset generally leads to the start (W_{p0}) of the selected program (parameter PNo).

Programmer RUN (START) / STOP can be input without option via di1/2 (**£. 190**) or via di4 (HW option B) (configurable; **£. 120, PStart**):

- Start signal via di1 (or di2)
di1 is a combination of control commands internal/external, reset and run and is used when di4 is not available. di1 = 0 switches the controller to internal set-point W ; the programmer is reset (reset, W_{p0}). With di1 = 0→1: the programmer is running when the operation/interface is set to "run/start"; the controller uses program set-point W_p .

i This function is possible only with int./ext. switch-over via di1/2. It is not possible with int./ext. switch-over via the controller front panel.

- Run/stop via di4 (and timer; **£. 192**)
The programmer runs (di4=1) and is stopped at di4=0. Operating mode internal/external remains unchanged.

Fig.: 69 Profile with stop at end position

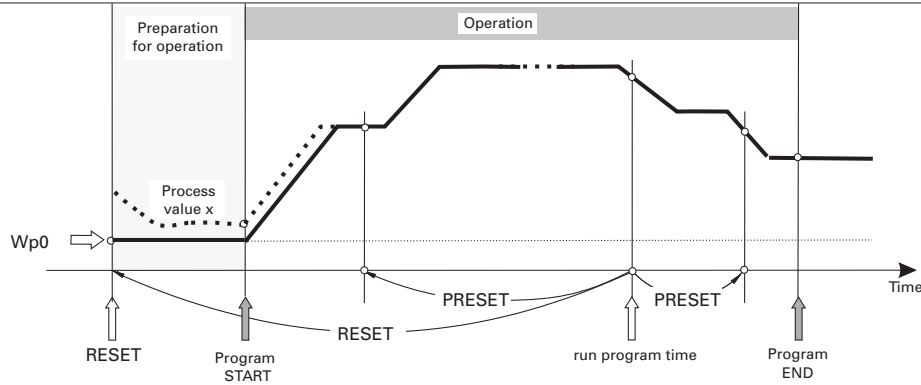
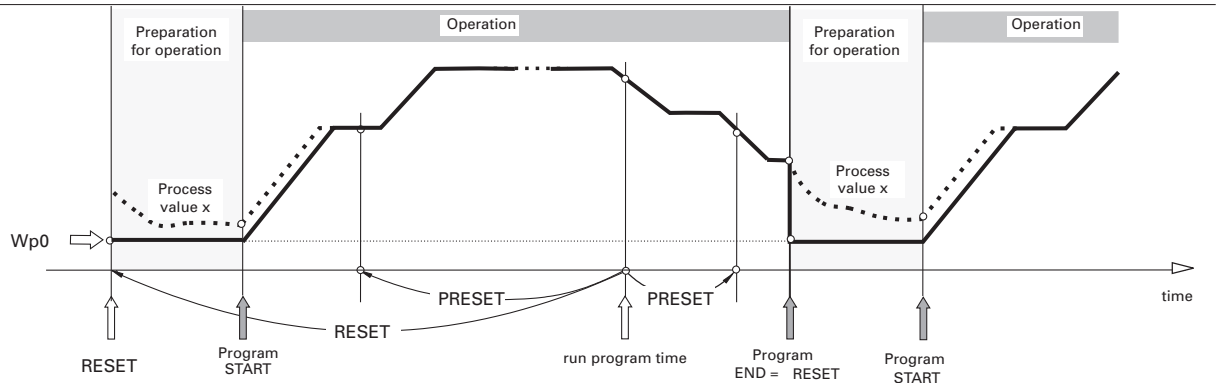

Fig.: 70 Profile with automatic reset at program end



13.1.9 Control signals and status messages

Control signals (reset, stop, ...) can be entered via control inputs (static) or via serial interface or via the front panel system menu (dynamic; edge-triggered) with equal priority

Run/start is required with program end with reset. If necessary, control input run/start must be switched off and on again.

The programmer stores the last status of control commands (capacitor-buffered RAM) so that operation from several points is generally possible.

Control signal priority

| Priority | Description | Reset | Preset | Stop | Run |
|----------|-------------|-------|--------|------|-----|
| 1 | Reset | 1 | 0 | 0 | 0 |
| 2 | Preset | 0/1 | 1 | 0 | 0 |
| 3 | Stop | 0/1 | 0/1 | 1 | 0 |
| Result | | Reset | Preset | Stop | Run |

0/1 = any status

13.1.10 Pre-requisites

For the following descriptions of the operating principle, the following setpoint-related pre-requisites which are already defined for controllers are applicable:

- general limitation of the rate of set-point change to the values adjusted for parameters Grw+ and Grw-. The gradients are adjustable with 3 digits behind the decimal point!
- storage of the external set-point We or of program set-point Wp (or of process value X; tracking: **£. 106 : WTrac**) as internal set-point W. Tracking can be activated only when switching back to the internal set-point! The relevant conditions are configurable (**£. 190 : STRac**):
 - a) Tracking not effective, or
 - b) tracking generally effective with We→W or Wp→W, or
 - c) as b), however, contact di2 or di12 is closed additionally.

13.2 Changes in the program sequence

Whilst the program is running, set-points and times (on-line) can be changed. Moreover, segments which were not available so far can be appended. The actual segment number remains unchanged. Unless the actual segment is changed, the relative elapsed time in the segment remains unchanged.

Past changes

A change of values and times in the past (already executed segments) is activated only after re-start (after previous reset).

Future changes

Future changes (segments which are not reached so far) are activated immediately. With changes of segment time, the “rest time” is re-calculated automatically.

Present changes

Changes of the actual segment time, which imply a step back into the past (e.g. reduction of segment time T_{pi} to lower values than the relative time already elapsed in this segment) cause a program step to the start value of the next segment. Set-point differences are compensated bumplessly with the gradients $Grw+/Grw-$ already adjusted at the controller; the programmer continues running.

Changes of the target value of the actual segment cause the segment gradient to be re-calculated once for this program run, in order to re-calculate the new target value in the remaining segment time. These (and all other) rates of change are limited by the pre-set set-point gradients $Grw+/Grw-$.

With a program reset and start or with preset to an earlier time, the final segment gradient is re-calculated.

13.3 Bandwidth monitoring

When leaving the bandwidth ($LC+ = \text{max. limit}$; $LC- = \text{min. limit}$) the programmer is stopped. The program continues running, when the process value is again within the pre-defined bandwidth. Fig.: 71 only shows the operating principle of the static program profile. Actually, however, the curve is delayed accordingly in the stop times.

Parameter: $LC+$ max. limit
 $LC-$ min. limit

Fig.: 71 Bandwidth monitoring

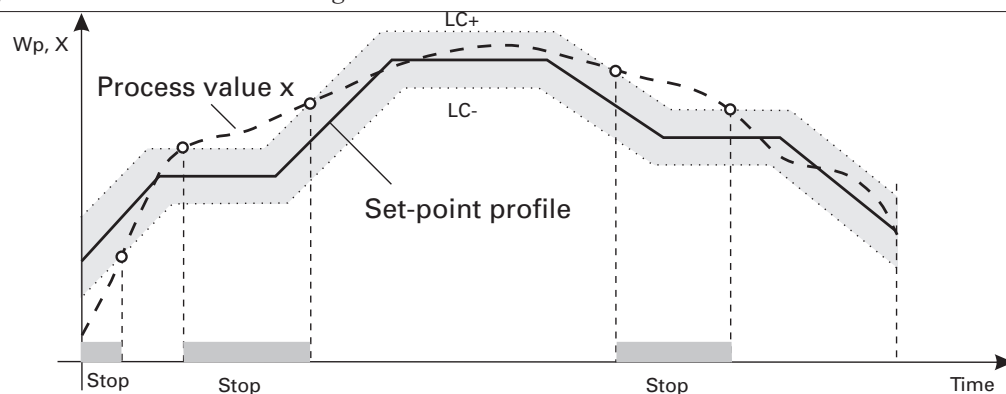



On instruments with software option ‘Programmer’ bandwidth monitoring is also effective with programmer not configured (controller operation). Parameters $LC-$ and $LC+$ are adjustable in the set-point parameters. Current set-point ramps ($Grw+/Grw-$) are stopped when leaving the band!

13.4 Manual programmer operation

The function of front panel key A/M () was already defined for controller operation (adjustable in the parameters; **FKey**). The adjustment range of this parameter contains the following points:

- -key without function
- Automatic / manual
- Wp / W (wext / wint)

Key  switches the programmer to internal set-point W adjustable with the arrow keys and back. In this case, key  is used for internal/external switch-over, whereby the programmer continues running in the background for the duration of “manual operation”. In the programmer reset position, key  switches over between $Wp0 \leftrightarrow W$.

Run \rightarrow W switch-over is bumpless with the controller configured for tracking (storage of W_e or W_p as internal set-point W; **£. 105** and **£. 190**). After switching back from manual (W) \rightarrow Run, the programmer starts from the instantaneous process value and searches the end value of the segment with gradient ($W_{pi} - W_{pi-1}$) / T_{pi} active when switching back (search mode).

13.5 Search mode (**£. 120**, **PWRUP**)

Search mode is started automatically after mains recovery, if the program was in run mode before mains failure and with “search mode” configured (**£. 120**; **PWRUP**).

Within the presently active segment, the program is continued at the point (time mark in future or past) at which process value and program set-point are equal. Relative program time in segment and rest time are corrected accordingly. If searching in the actual segment is not successful, the programmer behaviour is as follows (Fig.: 72, b...f):

| | |
|--|--|
| The programmer repeats the actual segment, with: | The programmer skips the actual segment and starts at the beginning of the next segment, if: |
| the gradient = 0, or, if the gradient > 0 and $X > W_i$, or | |
| if the gradient > 0 and $X < W_{i-1}$, or | if the gradient < 0 and $X < W_i$ |
| if the gradient < 0 and $X > W_{i-1}$. | |

Bumplessness is achieved by controller gradient limitation $Grw+$ / $Grw-$.

Fig.: 72 Automatical search mode

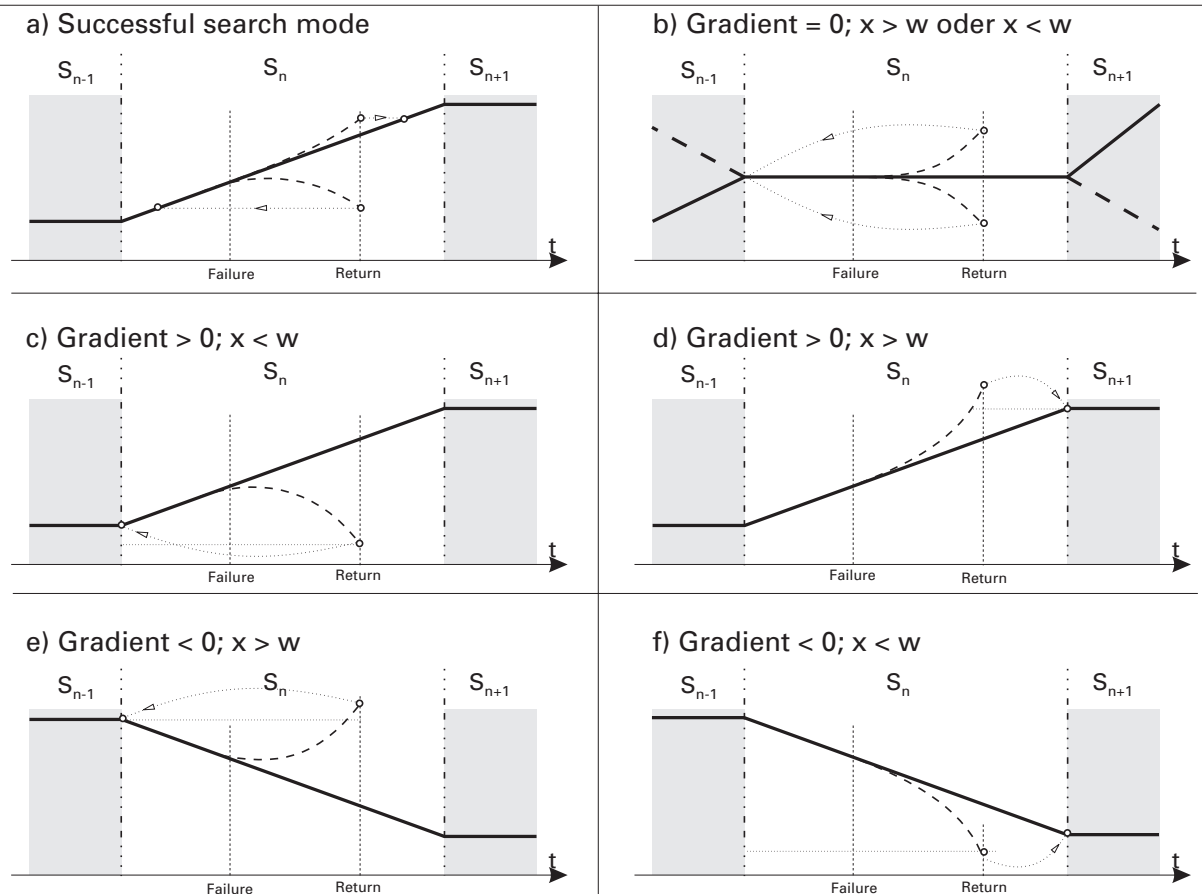

13.6 Behaviour after mains recovery and after removal of sensor errors

13.6.1 Memory loss (RAM)

With memory loss, the last program set-point and the time elapsed so far are not available any more. Therefore, the programmer is reset in this case. The controller uses set-point $W_p = W_{p0}$ and waits for further control commands:

- Start via contact or operation (system menu / serial interface)
- Preset

13.6.2 Memory (RAM) available

The behaviour is configurable (\checkmark , 120, PWRUP):

| PWRUP | Behaviour |
|-------|--|
| 0 | The program is continued at the point of failure (Fig.: 73 c). Starting from the instantaneous process value, the effective set-point runs towards the program set-point with the relevant gradient $Gr_{w\pm}$. The programmer continues running,, as long as bandwidth monitoring does not respond. |
| 1 | The programmer goes to manual mode (Fig.: 73 b). Despite applied control signals, the process value is stored as internal set-point W (with X-tracking configured) and the programmer waits for operator intervention. The program continues running. Without tracking, the internal set-point is effective. |
| 2 | Automatic search mode in the actual segment and program continuation (Fig.: 73 a). For unsuccessful search mode, see chapter ! |
| 3 | Automatic search mode in the actual segment (Fig.: 73 a). With unsuccessful search mode the programmer goes to manual mode (Fig.: 73 b) and the process value is stored as internal set-point W (with X-tracking configured). Without tracking |
| 4 | Program continuation in the segment, in which the programmer would have been without power failure. This function requires the KS9x real-time clock! Searching (Fig.: 73 a) and program continuation are in this segment. For unsuccessful search mode |

Fig.: 73 Behaviour after mains recovery and sensor fault

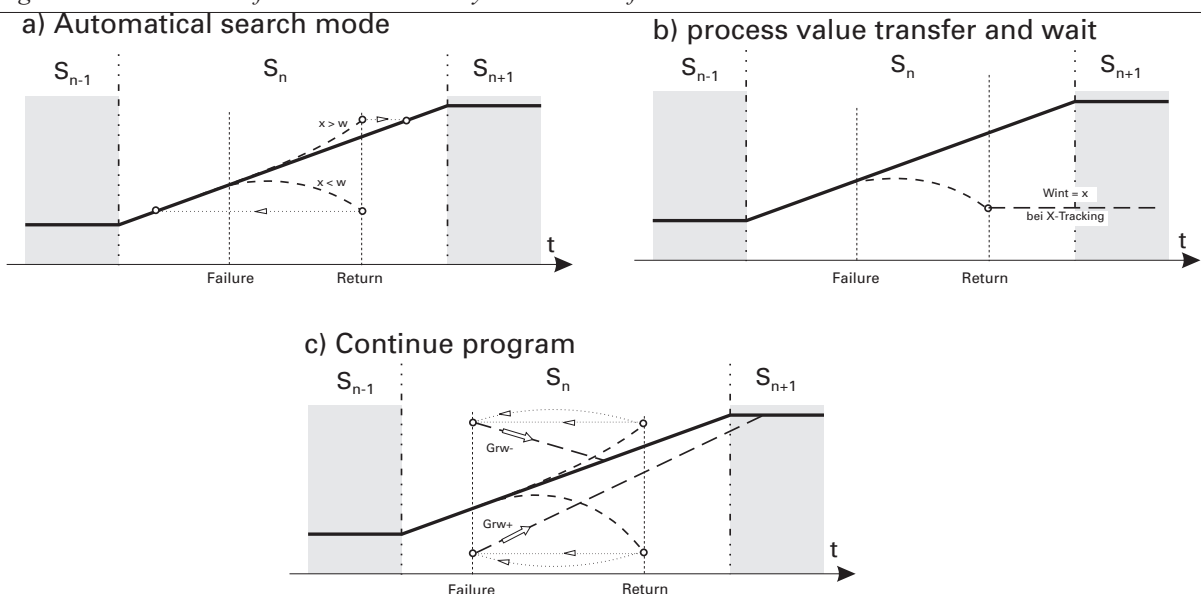

13.7 Preset

Preset sets the programmer to a defined point which is determined according to (**Pmode**) by

- a segment start ("preset to segment" **Pmode**= 0), or
- by a preset program time ("preset to time" **Pmode**= 1).

Preset value and command can be preset at the extended parameter level (\rightarrow page 89) and via serial interface. Any set-point differences are removed bumplessly with the controller gradients $Gr_{w\pm}$.

13.8 Sensor fault

With primary variable sensor fault, the programmer is stopped. After removal of sensor faults, the programmer behaviour is as after power failure (\rightarrow 13.6.2).

13.9 Programmer displays

13.9.1 "Display 1"

The actual process value is always displayed on display 1.

13.9.2 "Display 2"

The actual set-point is displayed at operating level on display 2.

At extended operating level, program times and actual programmer recipe number are displayed on display 2 (L. 120; PSe1 = 0).

Format of "display 2": "88.59" hours . minutes

With display overflow (>99 hours) only the full hours are displayed. The minute display is omitted: "188"

13.9.3 "Text 1"

At operating level, the selected unit is displayed in Text1. At extended operating level, the following displays relevant for the programmer can be selected (▲▼):

- program time **TNet**
(without pause times)
- program time **TBrut**
(incl. all pause times)
- rest time **TRest**
- recipe number **PNr**
- controller status **State**

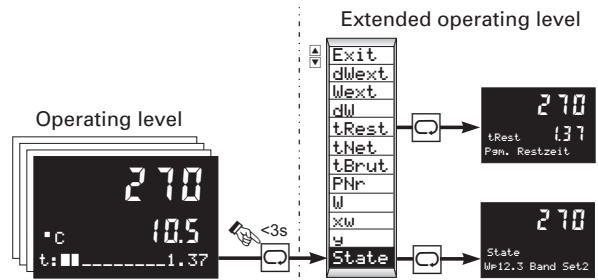

13.9.4 "Text 2"

Continuous display

The continuous display in "Text 2" is configurable (L800; Text 2). With program controller, the elapsed net program time TNetto can be displayed as Bargraph 0...100%. The dark part of the bargraph represents the rest time TRest, which is displayed right beside the bargraph. For TRest < 100 hours the rest time is displayed in hours • minutes. TRest > 99h is displayed in full hours.

Status indication

At extended operating level, KS94 text line "Text 2" is used as additional status display. "Text2" contains 16 characters, which are classified as follows.



| Set-point (symbol) | Explanations | Status | Explanations | Status | Explanations |
|--------------------|---|--------|---|--------|--|
| | Internal set-point | | no bandwidth monitoring and no program activ | ... | KS94 is in remote operation (front panel operation disabled) |
| We | External set-point | Band | Bandwidth monitoring has stopped programmer or set-point ramp | Loc | KS94 is in local mode (front panel operation possible) |
| Wp xx. y | Program set-point Segment number Program number | Grw | Set-point gradient presently limits the rate of change | | |
| W2 | Second set-point | Run | Programmer running | | |
| | | End | Program end is reached | | |
| | | Rset | Programmer is in reset state. | | |
| | | Stop | Programmer was stopped | | |

13.10 Programmer operation

Programmer operation (run, stop, reset, preset) is in menu1 via digital inputs or via interface (monitoring program).

Fig.: 74 Programmer operation via front keys

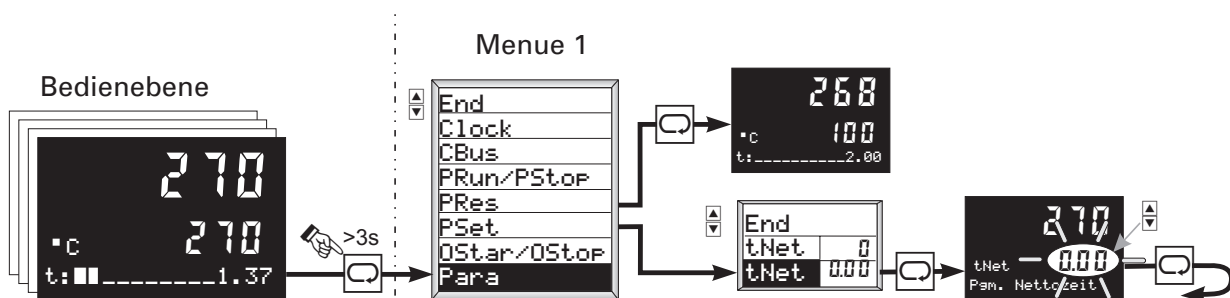

A preset time (parameter setting: Pmode = 1) can be entered in hours + minutes (times < 99.59) or only in hours (times > 99.59).

13.11 Inputs and outputs, parameters, configuration

from serial interface / front

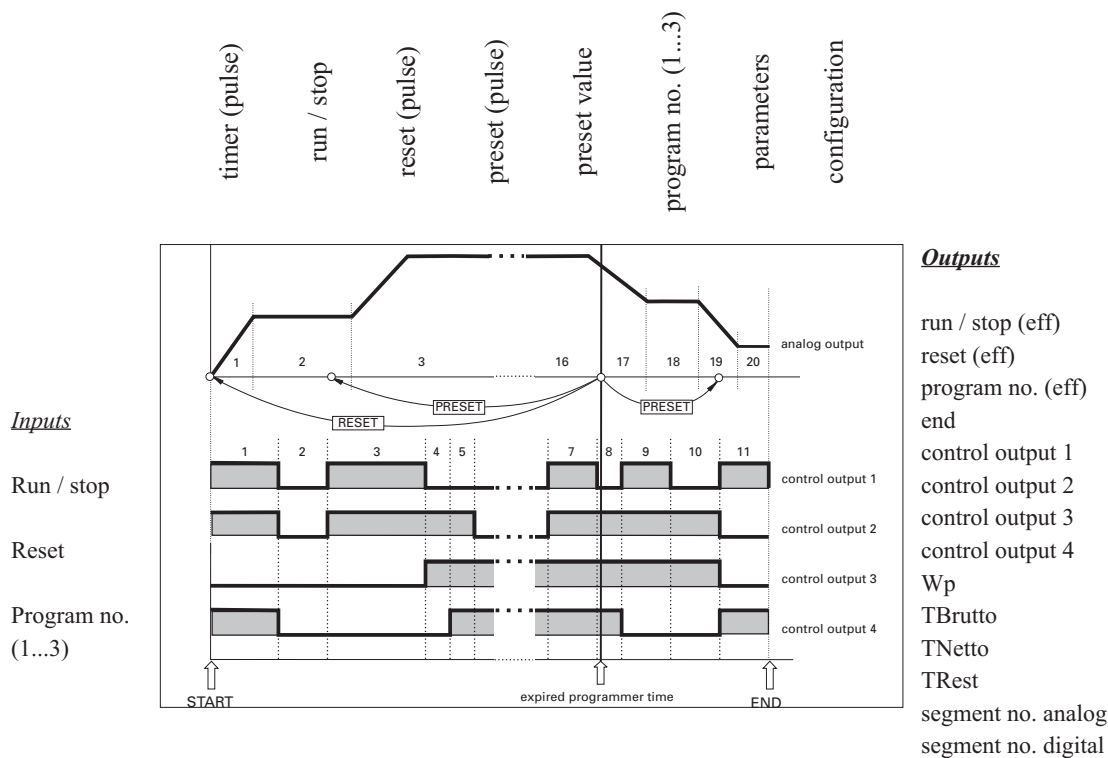

| Analog inputs | Analog outputs |
|---|--|
| Process value (from controller) | Set-point Wp |
| Manual set-point (internal set-point W of controller) | Program time Tnet |
| Program selection via front panel/interface | Program time Tgross |
| | Rest time TRest |
| | Actual segment number Seg a (analog output) and Seg d (control output) |
| | Final value of actual segment |

| Control inputs | Control outputs |
|--|---|
| Run(start)/stop (static) | end |
| Reset (flank) | e/i (ext./int.) |
| Failure (Fail) | reset |
| ext/int | stop/run |
| PrNr via digital inputs | |
| Preset via operation | |
| Parameter | Configuration |
| Reset value Wp0 | Source of program selection (control inputs, front/interface) |
| segment parameters Wpi / Tpi | source of run/stop signal |
| Change mode Wmode "step / ramp" | behaviour after program end |
| (valid for all segments; default: ramp) | Behaviour after mains failure |
| Function of A/M key FKey | Default display in "Text 2" |
| Bandwidth LC+ | Bargraph TNetto = 0...100% |
| Bandwidth LC- | |
| Preset mode Pmode "time / segment start" | |
| (for all outputs; default: preset to time) | |
| Preset value (system menu) | |
| Timer (parameter) | |
| Time (real-time clock; system menu) | |

14 Timer

14.1 Definition

KS9x versions with built-in real-time clock (HW option B with RS422/485) can start automatically at a pre-set time. For this purpose, a time can be set (year, month, day, hour, minute): e.g. on 23/07/95 at 6.35 h



The timer comprises a switch-on time (start; **TS. xx**) and a switch-off time (stop; **TE. xx**). Both switching times are adjusted absolutely (day ! month ! year ! hour ! minute). The switch-off time **Tstop** is generally adjustable, however, it is not evaluated with the programmer. The two trigger points can be used also for switching over w/W2, y/Y2 and for controller output switch-off (**SOURCE; C. 190 ff**). Timers are adjusted at parameter level. When entering a start time with an actual start time < **TStart Timer** ' is displayed in Text1.

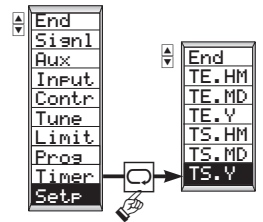

Timer function after mains recovery

The behaviour is dependent of whether the start time or start and stop time are already exceeded at the time of mains recovery:

- **TStart < actual time > TStop**
The timer output is activated immediately and the relevant action is triggered (program START)
- **TStart < TStop < actual time**
The programmer is started; the stop marker does not switch! Switch-over functions w/W2, and y/Y2 and controller output switch-off are activated during approx. 1s with these functions configured.

14.2 Entry of times and timers

Adjustment is sequentially via the front panel (time in the system menu, timer at parameter setting level) or via serial interface (saved in EEPROM). Adjustment can be started at any step so that year and month/day can be skipped. The entry sequence must be continued after starting. Cancellation is not possible. The values are displayed in "display 2":

- 1st step: year 1970
- 2nd step: month • day 0 10 1
- 3rd step: hour • minute 00.00

The time is capacitor-buffered (separate from the RAM buffer) for approx. 2 days! With memory loss, "ClckF" is displayed in Text 1.

15 User-defined texts

15.1 Text1

With configuration `LB01`; **LUnit** = 99, a free text of 5 characters (all displayable 7-bit ASCII characters) can be entered via the engineering tool or via the serial interface and displayed in "Text 1".

15.2 Text2

Up to 12 free texts of 16 characters each (all displayable characters from 7-bit ASCII) can be entered with the engineering tool (or via the serial interface) and displayed alternately in "Text 2" and on the continuous display.

The display in "Text 2" can be activated from two sources (configurable; `LB00`, **Text2**):

- "internal status" (alarms, control outputs, recipes, bandwidth)
- Control inputs di1...di12

With several simultaneous statuses or control inputs, the relevant texts are displayed sequentially at intervals of 5s:

User text 1 ! Bargraph ! User text 2 ! Bargraph ! ... User text n ! Bargraph ! User text 1 ! ...



If the text display is triggered via control inputs di (`LB00`), the statuses of the control inputs will be read also if they are not used for controller/programmer function control!

| <i>Text</i> | User texts (Text 2) can be activated by ... | |
|-------------|---|--------------------|
| | ... status | ... digital inputs |
| 1 | LIM1 | di1 |
| 2 | LIM2 | di2 |
| 3 | LIM3 | di3 |
| 4 | LIM4 | di4 |
| 5 | Control output 1 | di5 |
| 6 | Control output 2 | di6 |
| 7 | Control output 3 | di7 |
| 8 | Control output 4 | di8 |
| 9 | Program 1 | di9 |
| 10 | Program 2 | di10 |
| 11 | Program 3 | di11 |
| 12 | Bandwidth LC+/- | di12 |

16 Configuration

16.1 General

The KS94 controller configuration for quick and easy function selection during subsequent operation is described in this section. During configuration, the required functions are selected from a large variety of available functions. The configuration determines the basic structure for solution of an application.



The configuration structure is designed so that determination of the required functions for a large number of applications is possible by adjustment of as few configuration words as possible. Moreover, the structure was designed flexible enough to permit additional configurations also for realization of special applications.

16.2 Basic structure

The first menu level permits selection of the main configuration group.

The user can be guided through all function configurations, or he can configure the specific functions required for his application directly.

For all 'complex' main groups, a two-level configuration concept which enables the user to select the 'correct' setting for his application by defining only one configuration word was determined. If necessary, special functions can be determined separately. For the 'normal user', however, the configuration words are preset to purposeful default values! For simplification, the hierarchic configuration dialogue is structured so that the user can and must adjust only the 'required' configuration words.

The user configuration dialogue is started via selector key  and 'increment' / 'decrement' keys , like with the other KS92/94 operating levels:

- Press the selector key to select menu items / input values / input positions within a 'level' and to change over to the next higher level at the end of a 'level'.
- Press the 'increment' / 'decrement' keys for returning to a lower level and for modification of input values.

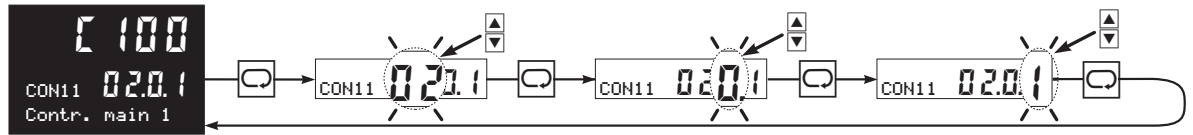

The configuration structure is shown on the two following pages (16 and 17). All possible configuration words are listed. Configuration words which are irrelevant for a function are not displayed during the dialogue!

Switch-over to a selection menu is possible from anywhere during configuration by pressing key  >3s.

- End:** Return to configuration level
- More:** Activating the More function
- Quit:** Return to operating level
(configuration changes are not effective)
- Exit:** Return to operating level (configuration changes are effective and the controller is re-initialized).

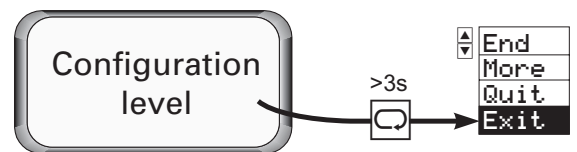

16.3 Main groups

The following main configuration groups are available for KS9x controller configuration:

| | | | | | |
|---------------|---------------------|--------------|-----|--------------|------------|
| Contr | Controller function | C.100 | ... | C.139 | → page 99 |
| Sourc | Input allocation | C.180 | ... | C.192 | → page 101 |
| Input | Input function | C.200 | ... | C.487 | → page 103 |
| Output | Output function | C.500 | ... | C.597 | → page 107 |
| Alarm | Alarm function | C.600 | ... | C.660 | → page 111 |
| Tune | Self-tuning | C.700 | | | → page 112 |
| Disp | User interface | C.800 | | | → page 112 |
| Aux | Additional function | C.900 | ... | C.994 | → page 113 |

The main configuration groups are structured in a hierarchical order, whereby determination of a dialogue for prompting only the really relevant configurations is possible.



ENGINEERING TOOL 'ET/KS 94'

Engineering Tool ET/KS94 permits realization of all operations which are possible via the KS94 front panel on a PC, whereby controller configuration and parameter setting are facilitated considerably.

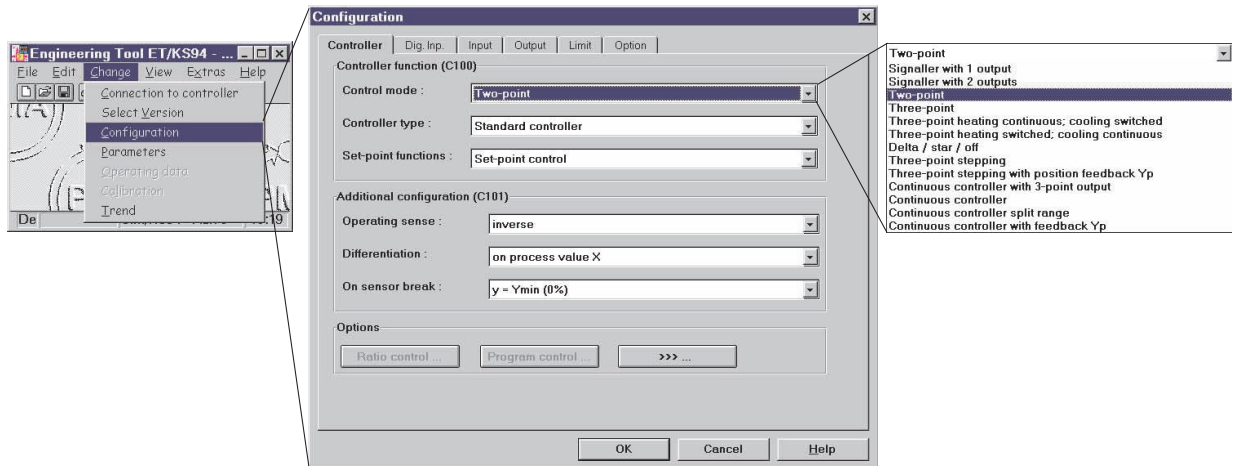

The engineering tool offers the following functions:

- Creation and modification of the parameter set
- Transmission of a parameter set to KS94
- Read-out of a parameter set from a KS94
- Long-term storage of various parameter sets on hard disk or floppy
- Display of operating data

Connection of PC and KS94 controller is via an RS232/TTL adaptor cable, which must be ordered separately (ordering information → see page 43 section 12). In conjunction with the 'SIM/KS 94' controller simulation, a graphic trend display of the real process data is available!

16.4 CONTR: Controller

This main group determines the controller structure and function, which is used as starting point for controller configuration for a particular application. The main controller configuration **C. 100** leads to an input and output pre-adjustment (**C. 180 .. C. 190**, **C.500 .. C.599**). This 'proposal' must always be checked before commissioning and corrected, if necessary. After determination of this word, no further settings are required for a large number of applications. Additional function adaptations are possible via configuration words **C. 105** and the following configurations.



Main controller configuration 1:

| CFunc (Control behaviour) → p. | CType (Controller type) | WFunc (Set-point function) |
|---|--|--|
| 00: signaller 1 output 01: signaller 2 outputs 02: 2-pnt.controller 03: 3-pnt.controller (heating switching and cooling switching) 04: 3-pnt.controller (heating continuous and cooling switching) 05: 3-pnt.controller (heating switching and cooling continuous) 06: Δ/Y-off 07: 3-pnt.stepping 08: 3-pnt.stepping with Yp (INP6) 09: continuous with position controller 10: continuous 11: continuous split-range (only with Optim C; OUT1 and OUT3) 12: continuous with current feedback via Yp (INP6) | 0: standard controller 1: ratio controller (→ C. 107) 2: 3-element controller $x_{eff} = x1 + a \cdot (x2 - x3)$ 3: mean value $x_{eff} = (1 - b) \cdot x1 + b \cdot x2$ | 0: set-point 1: set-point / cascade 2: programmer 3: set-point with ext. offset 4: set-point / cascade with internal offset 5: set-point / cascade with external offset 6: programmer with internal offset 7: programmer with external offset |

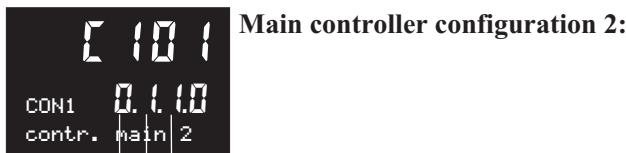

Main controller configuration 2:

| CMode (Output action) | CDiff (Differentiation) | CFail (Controller behaviour with main variable sensor break) |
|--------------------------|---|--|
| 0: inverse 1: direct | 0: differentiate Xw 1: differentiate X | 0: neutral (controller outputs switched off) 1: Ypid = Ymin (0) 2: Ypid = Ymax (100) 3: Ypid = Y2 (adjustment via front panel not possible) 4: Ypid = Y2 (adjustment via front panel possible) |

More



Use of an auxiliary variable and external y limiting:

| | |
|--|---|
| CAux (Auxiliary variable z via INP3/6) | COVC (Output limiting) |
| 00: no 01: X+Z in conjunction with the process value without differentiation 02: X-dZ/dt in conjunction with the process value with differentiation in both directions 03: X+dZ/dt in conjunction with the process value with differentiation and positive change 04: X-dZ/dt in conjunction with the process value with differentiation and negative change 05: Y+Z in conjunction with the correcting variable without differentiation 06: Y-dZ/dt in conjunction with the correcting variable with differentiation in both directions 07: Y+dZ/dt in conjunction with the correcting variable with differentiation and positive change 08: Y-dZ/dt in conjunction with the correcting variable with differentiation and negative change | 0: No external limiting 1: OVC+ 2: OVC- |

More



Set-point functions:

(only with option C, Wext and not with 3-element controller)

| | | |
|---|--|---|
| wTrac (Behaviour of Wint when switching over from Wext to Wint with the w tracking input switched on) | dW (Type of set-point tracking.) | w Sel (MIN/MAX selection) |
| 0: Set-point tracking 1: Process value tracking | 0: additive 1: factor | 0: no selection 1: Max selection Weff 2: Min selection Weff |

Ratio functions: (only with ratio controller)

More



| | |
|---|---|
| Ratio (Ratio control function) | XDP (Process value decimal point) |
| 1: $(x1 + N0) / x2$ 2: $(x1 + N0) / (x1 + x2)$ 3: $(x2 - x1 + N0) / x2$ | 0: no digit behind decimal point 1: 1 digit behind decimal point 2: 2 digits behind decimal point 3: 3 digits behind decimal point |

More

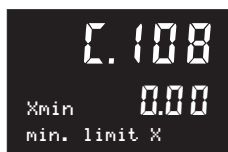

Span start X0: (only with ratio controller)

Xmin:(min. process value limiting Xmin)
 Numeric value: -999 ... 9999

More

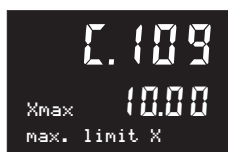

Span end X100: (only with ratio controller)

Xmax:(max. process value limiting Xmax)
 Numeric value: -999 ... 9999 and Xmin Xmax

More

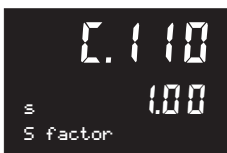

Factor for stoichiometric ratio s: (only with ratio controller)

S: stoichiometric ratio
 Numeric value: 00.00 ... 99.99 (2 fixed digits behind decimal point)

More

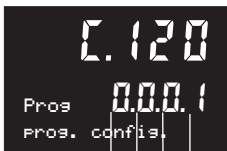

Programmer configuration:

(only with programmer configured)

| PSe1 (Source for program selection) | PwrUP (Behaviour with mains recovery) | PEnd (Behaviour with program end) | PStrt (Source for Run/Stop) |
|--|---|---|--|
| 0: program selection via operation 1: program selection via control input | 0: continue program 1: stop program and switch over to Wint 2: continue program after automatic research 3: continue program after successful automatic research otherwise switch over to Wint 4: continue program at the time mark of mains recovery | 0: continue with following program 1: following program and reset (start required) | 0: start/stop and reset together ¹⁾ . control with int/ext (without Option B) 1: start/stop and reset separate. (Option B) |

16.5 SOURCE: Input signal allocation

Input signal allocation is dependent of main controller configuration 'C.100'. this proposal must always be checked before commissioning and corrected, if necessary. Therefore, input signal allocation 'SOURCE' is no independent main item and considered as additional configuration of 'CONTR'.



Signal allocation analog signals:

| S X2 (Signal source for X2 with ratio and three-element controller) | S Wext (Signal source for Wext with controller with external set-point) | S dW (Signal source for W with controller with set-point offset) | S Z (Signal source for auxiliary variable) |
|--|---|---|---|
| 0: X2 switched off 1: X2 of INP5 2: X2 of INP3 | 0: Wext switched off 1: Wext of INP5 2: Wext of INP6 3: Wext of INP4 | 0: dW switched off 1: dW of INP5 2: dW of INP6 3: dW of INP4 | 0: z switched off 1: z of INP3 2: z of INP6 3: z of INP4 |

1) *C.190; SWi/e select the source for int/ext-switching.



Allocation of digital signals for set-point processing:

| Swi/e | STrac | SdWon | Sw/W2 |
|---|--|---|--|
| (Set-point switch-over from internal to external) ¹⁾ | (Bumpless switch-over to int. set-point with int./ext. switch-over) | (Effective set-point offset) | (Switch-over to set-point w2) |
| 0: only internal set-point 1: W/Wext via front 2: di1=external set-point 3: di2=external set-point 4: di1= internal set-point 5: di2= internal set-point | 0: no tracking ²⁾ 1: tracking on 2: di2 = tracking on 3: di12 = tracking on 4: di2 = tracking off 5: di12 = tracking off | 0: no offset ²⁾ 1: offset on 2: di1 = offset on 3: di2 = offset on 4: di11 = offset on 5: di1 = offset off 6: di2 = offset off 7: di11 = offset off | 0: no W2 ²⁾ 1: fixed to W2 2: di1 = W2 3: di2 = W2 4: di12 = W2 5: Timer = W2 6: di1 = W 7: di2 = W 8: di12 = W |



Allocation of digital signals for the controller functions:

| S A/M | SPI/P | SY2on | SCoff |
|---|---|--|--|
| (Automatic / manual (manual switch-over)) | (3.pnt.stepping controller: feedback off, otherwise PI / P switch-over) | (Output of safe correcting value) | (Switch-off controller) |
| 0: auto/manual via front 1: fixed to manual 2: di1 = manual 3: di2 = manual 4: Backup run 5: di1 = auto 6: di2 = auto | 0: PI fixed ²⁾ 1: fixed to P action 2: di1 = P action 3: di2 = P action 4: di1 = PI action 5: di2 = PI action | 0: Y no Y2) ²⁾ 1: fixed to Y2 2: di1 = Y2 3: di2 = Y2 4: timer = Y2 5: di1 = Y 6: di2 = Y | 0: controller on/off via front (W = '—') 1: controller fixed to off 2: di1 = controller off 3: di2 = controller off 4: timer= controller off 5: di1= controller on 6: di2= controller on |

More



Allocation of digital signals for the programmer:

(only with programmer configured)

| SPrSt |
|--|
| (Signal source for programmer run/stop) |
| 0: Run/Stop: Front 1: Run/Stop: di4 2: Run/Stop: di4 and timer 1 |

- 1) With programmer configured, switch-over is between internal and program set-point.
- 2) Selectable via interfaces (e.g. engineering tool; operating data)

16.6 INPUT:

The signal inputs for the previously selected controller configuration are determined in this main group. The signal inputs required for the selected controller function are displayed in the menu for configuration. As during control function configuration, a large number of applications can also be covered by determining the main configuration. At the second level, special cases can be matched and adjusted by additional, optional configuration. Max. 5 signal inputs are provided on KS94. Analog inputs INP1, INP5 and INP6 are always provided; INP3 and INP4 are optional inputs.

All analog inputs (whether or not used for control) can be used for monitoring purposes (e.g. alarm processing).

16.6.1 Signal input 1 / INP1 (main variable x1)

Configuration is for main variable x1. This signal input is a universal input for which extensive functions can be configured.



INP1
main confis.

Main configuration:
The main configuration word is used for determination of input sensor type and physical unit. Additional input configurations can be determined using the additional configuration.

| Type (Sensor type) | Unit (Unit) ¹⁾ | DP (Number of decimals) |
|---|--|--|
| <p>Thermocouple: 00: Type L 0 ... 900 °C 01: Type J 0 ... 900 °C 02: Type K 0 ... 1350 °C 03: Type N 0 ... 1300 °C 04: Type S 0 ... 1760 °C 05: Type R 0 ... 1760 °C 06: Type T 0 ... 400 °C 07: Type W 0 ... 2300°C 08: Type E 0 ... 900 °C 09: Type B (0) ... 400 ... 1820°C</p> | <p>Resistance thermometer: 20: Pt 100 -99.9 ... 850.0 °C 21: Pt 100 -99.9 ... 250.0 °C 25: 2 x Pt 100 -99.9 ... 850.0 °C 26: 2 x Pt 100 -99.9 ... 250.0 °C</p> <p>Standard signals: 30: 0 ... 20 mA 31: 4 ... 20 mA 32: 0 ... 10 V 33: 2 ... 10 V</p> <p>Potentiometric transducer: 40: 0 ... 500 Ohm</p> | <p>0: at Typ 30...40 1: °C 2: °F</p> |
| | | <p>0: no decimal point 1: 1 digit behind the decimal point 2: 2 digits behind the decimal point 3: 3 digits behind decimal point</p> <p><i>only with type: 20 ... 40</i></p> |

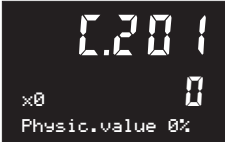

x0
Physic.value 0%

x0:
(physical value at 0%)
numeric value -999 ... 9999
select only with type = 30 ... 40

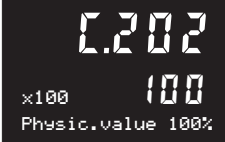

x100
Physic.value 100%

x100:
(physical value at 100%)
numeric value -999 ... 9999 , X0 ≠ X100!
select only with type = 30 ... 40

1) Unit settings for scaling of Typ 00...26. With Typ 30...40 the value is fixed to 0. For this case the unit to be displayed will be configured by **C.801**.

More



Additional configuration:

Via the additional configuration, the default setting for the signal input can be changed or matched dependent of sensor type class.

| Fail (Signal behaviour with sensor fault) ¹⁾ | STk (Temperature compensation) | XKorr (Process value correction enable) |
|--|--|--|
| 1: upscale(X100) 2: downscale(X0) 3: XFail (0.2 13) | 0: not effective 1: internal TC 2: external TC (TC fixed in 0.2 10!) | 0: not effective 1: with process value correction (adjustable via parameters x1in,x1out,x2in,x2out) |
| Type: 00...26, 31, 40 | type: 00 ... 09 | |
| Non-selectable digits are marked by '0' | | |

More

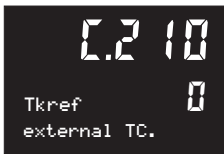

Tkref:

(external TC)
numeric value: -99 ... 100 °C or °F
select only with type: 00...08 and STk = 2

More

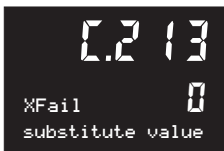

XFail:

(substitute value with sensor error)
numeric value: -999 ... 9999

More



Tfm:

(filter time constant for input value processing)
numeric value: 0.0 ... 999.9

More



Optional configuration 1:

The optional configuration can be used to determine the functions for two signal pre-processing levels.

| Func1, Func2 (Function selection for signal pre-processing) | LDp (decimal point for gain, Xeff and yki) |
|---|--|
| 0: no function, signal is output directly 1: scaling (parameters: m,b) 2: linearization (segment points xs1,ys1 ...) 3: filter (parameter: Tf) 4: square root extraction with factor (parameter:gain) | 0: no decimal point 1: 1 digit behind the decimal point 2: 2 digits behind the decimal point 3: 3 digits behind decimal point |

1) The **Fail** adjustment does not affect the controller behaviour. With sensor error, the controller behaviour is always as determined in 0.10! (**Cfail**). The signal behaviour with sensor error acts only on a configured alarm. With a process value, x1 or INP1 alarm configured, the signal goes e.g. to the upscale value (X100) with sensor error.

More



Linearization parameters:

The configuration parameters for linearization are stored as follows.

| | | | | |
|-------|-----|-------|-----|--------------|
| 0.222 | xs1 | 0.223 | ys1 | value pair 1 |
| 0.224 | xs2 | 0.225 | ys2 | value pair 2 |
| 0.226 | xs3 | 0.227 | ys3 | value pair 3 |
| 0.228 | xs4 | 0.229 | ys4 | value pair 4 |
| 0.230 | xs5 | 0.231 | ys5 | value pair 5 |
| 0.232 | xs6 | 0.233 | ys6 | value pair 6 |
| 0.234 | xs7 | 0.235 | ys7 | value pair 7 |
| 0.236 | xs8 | 0.237 | ys8 | value pair 8 |



Note that the input values (x-values) must be entered in ascending order. (xs1<xs2<xs3...)

The range for these configuration words is within -999 and 9999 or '----' (switched off)!



For limiting the number of parameters, these functions can be used only once during pre-processing levels 1 or 2! Linearization segment points which are not required can be switched off by setting '----'.

16.6.2 Signal input 3 / INP3 (ratio variable x2 or auxiliary variable z)

In this case, the signal is configured for ratio variable x2 or auxiliary variable z, provided that option p.c.b. C is fitted in the controller and the function was selected during controller configuration.



Main configuration:

Selection is only possible with option p.c.b. C provided.

| Type (Sensor type) | DP (Number of digits behind the decimal point) |
|--|--|
| Standard signals: 30: 0 ... 20 mA 31: 4 ... 20 mA | 0: no decimal point 1: 1 digit behind the decimal point 2: 2 digits behind the decimal point 3: 3 digits behind decimal point |

More



Additional configuration:

The additional configuration can be used for changing or matching the signal input default setting for the sensor type.

| Fail (Signal behaviour with sensor error) |
|--|
| 1: upscale (X100) 2: downscale (X0) 3: XFail (E3 I3) |

The other configuration words for INP3 are explained in section (see following table).

| | | | | |
|--------------------------|-------|-----|-------|------------------------------------|
| X0 | [.301 | see | [.201 | |
| X100 | [.302 | „ | [.202 | |
| XFail | [.313 | „ | [.213 | |
| Tfm | [.314 | „ | [.214 | |
| optional configuration 1 | [.320 | „ | [.220 | without linearization (Func1/2: 2) |

16.6.3 Signal input 4 / INP4 (variable x3, ext. set-point Wext, override control ovc+/-)

The signal for three-element variable x3 or the galvanically isolated external set-point Wext or the override control signal ovc+/- are configured with option p.c.b. C fitted in the controller and the function selected during controller configuration.

The configuration words for INP4 are explained in section and (see following table).

| | | | | |
|--------------------------|-------|-----|-------|--|
| Main configuration | [.350 | see | [.300 | |
| X0 | [.351 | „ | [.201 | |
| X100 | [.352 | „ | [.202 | |
| Additional configuration | [.355 | „ | [.305 | |
| XFail | [.363 | „ | [.213 | |
| Tfm | [.364 | „ | [.214 | |
| Optional configuration 1 | [.370 | „ | [.220 | |
| Optional configuration 2 | [.371 | „ | [.221 | |
| | [.372 | „ | [.222 | |
| Linearization table | [.381 | | [.231 | |

16.6.4 Signal input 5 / INP5 (ratio variable x2, ext. set-point Wext)

The signal for ratio variable x2 or external set-point Wext is configured with option p.c.b. not fitted in the controller and the function selected during controller configuration. The configuration words for INP5 are explained in section and (see following table).

| | | | | |
|--------------------------|-------|-----|-------|------------------------------------|
| Main configuration | [.400 | see | [.300 | additional 0/2...10V (type: 32/33) |
| X0 | [.401 | „ | [.201 | |
| X100 | [.402 | „ | [.202 | |
| Additional configuration | [.405 | „ | [.305 | |
| XFail | [.413 | „ | [.213 | |
| Tfm | [.414 | „ | [.214 | |
| Optional configuration 1 | [.420 | „ | [.220 | without linearization (Func1/2: 2) |

16.6.5 Signal input 6 / INP6 (auxiliary variable Yp, feedback Yp)

The signal for the auxiliary variable Yp or for the position feedbackk is configured, if this was selected during controller configuration.

The configuration words for INP6 are explained in section and (see following table).

| | | | | |
|--------------------------|-------|-----|-------|--|
| Main configuration | [.450 | see | [.300 | additional potentiometric transducer for Yp (type: 40) |
| X0 | [.451 | „ | [.201 | |
| X100 | [.452 | „ | [.202 | |
| Additional configuration | [.455 | „ | [.305 | |
| XFail | [.463 | „ | [.213 | |
| Tfm | [.464 | „ | [.214 | |
| Optional configuration 1 | [.470 | „ | [.220 | without linearisierung (Func1/2: 2) |

16.7 OUTPT:

16.7.1 Signal output 1 / OUT1

Used for configuring the source of output OUT1. This signal output is a universal output which can be configured for extensive functions.



Main configuration:

| Src (Signal source) | Type (Output stage) | Mode (Motor actuator output action) |
|--|--|--|
| 00: output switched of 01: controller output Y1/Yout1 02: controller output Y2/Yout2 03: output Ypid 04: position feedback Yp 05: controlling deviation Xw 10: process value Xeff 11: X1 12: X2 13: X3 20: set-point W 21: external set-point Wext 22: external offset dWe 23: set-point Weff 24: programmer set-point Wprg 25: alarm 1 (limit1) 26: alarm 2 (limit2) 27: alarm3 (limit3) 28: alarm 1 (limit4) | 0: relay (switching) 1: 0 ... 20 mA (continuous output) 2: 4 ... 20 mA (continuous output) 3: 0 / 20 mA (logic) | 0: not selectable 1: direct / normally open 2: inverse / normally closed |

More



Additional configuration Out1:

Via the options configuration, the functionality for a signal post-processing stage can be determined. This configuration word is displayed only with the option enabled.

| Func (Function selection for signal output processing) | DP (decimal point for xsi,x0,x100) |
|--|--|
| 0: no function, signal is output without change (0%...100%) 1: scaling (reference values C.510 and C.511 are effective) | 0: no decimal point 1: 1 digit behind decimal point 2: 2 digits behind decimal point 3: 3 digits behind decimal point |

More



X0:

(physical value at 0%)
Numeric value -999 ... 9999

More

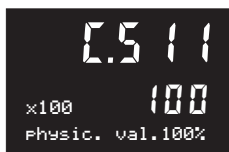

x100:

(physical value at 0%)
Numeric value -999 ... 9999

16.7.2 Signal output 2 / OUT2

Used for configuring the source of output OUT2. This signal output is a universal output and can be configured for extensive functions.



Main configuration:

| Src (Signal source) | Type (Output stage) | Mode (Motor actuator output action) |
|---|------------------------|--|
| 00: output switched off 01: controller output Y1/Yout1 02: controller output Y2/Yout2 25: alarm1 (limit1) 26: alarm2 (limit2) 27: alarm3 (limit3) 28: alarm4 (limit4) | 0: relay (switching) | 0: not selectable 1: direct / normally open 2: inverse / normally closed |

16.7.3 Signal output 3 / OUT3

Used for configuring the source of output OUT3. This signal output is a universal output and can be configured for extensive functions.

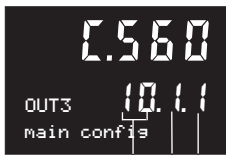

Main configuration:

Selection is only possible with option C fitted.

| Src (Signal source) | Type (Output stage) | Mode (Motor actuator output action) |
|--|---|---|
| 00: none (output switched off) 01: controller output Y1/Yout1 02: controller output Y2/Yout2 03: controller output Ypid 04: position feedback Yp 05: control deviation xw 10: process value xeff 11: process value x1 | 12: process value x2 13: process value x3 20: set-point Wint 21: ext. set-point Wext 22: ext. Offset dWe 23: set-point Weff 24: programmer Wprg | 0: switched off 1: 0 ... 20 mA (continuous output) 2: 4 ... 20 mA (continuous output) 3: 0 / 20 mA (logic) |
| | | 0: not selectable 1: direct / normally open 2: inverse / normally closed |

More



Additional configuration:

The optional configuration can be used for determining the functions for signal post-processing. This configuration word is displayed only with the option enabled.

| Func. (Function selection for signal output processing) | DP (decimal point for xsi,x0,x100) |
|---|--|
| 0: no function, signal is output directly (0%...100%) 1: scaling (reference values C.570 and C.571 are effective) 2: linearization (segment points xs1,ys1 ...) | 0: no decimal point 1: 1 digit behind the decimal point 2: 2 digits behind the decimal point 3: 3 digits behind decimal point |

More



x0:

(physical value at 0%)
numeric value -999 ... 9999

More

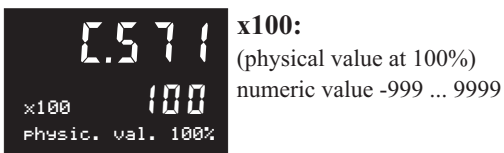

x100:
(physical value at 100%)
numeric value -999 ... 9999

More



The configuration parameters for linearization are stored as follows.

| | | | | |
|-------|-----|-------|-----|--------------|
| 0.572 | xs1 | 0.573 | ys1 | value pair 1 |
| 0.574 | xs2 | 0.575 | ys2 | value pair 2 |
| 0.576 | xs3 | 0.577 | ys3 | value pair 3 |
| 0.578 | xs4 | 0.579 | ys4 | value pair 4 |
| 0.580 | xs5 | 0.581 | ys5 | value pair 5 |
| 0.582 | xs6 | 0.583 | ys6 | value pair 6 |
| 0.584 | xs7 | 0.585 | ys7 | value pair 7 |
| 0.586 | xs8 | 0.587 | ys8 | value pair 8 |



Note that the input values (x-values) must be entered in ascending order.
($x_{s1} < x_{s2} < x_{s3} \dots$)

The range for these configuration words is within -999 and 9999 or '—' (switched off)!

16.7.4 Signal output 4 / OUT4

Used for configuring the source of output OUT4. This signal output can be configured for extensive functions.

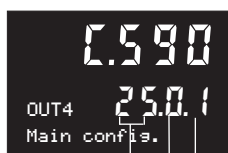

Main configuration:

| Src (Signal source) | | Type (Output stage) | Mode (Actuator output action) |
|--------------------------------|-------------------------|------------------------|---|
| 00: output switched off | 28: alarm 4 (limit4) | 0: relay (switching) | 0: not selectable 1: direct / normally open 2: i nverse / normally closed |
| 01: controller output Y1/Yout1 | 29: programmer output 1 | | |
| 02: controller output Y2/Yout2 | 30: programmer output 2 | | |
| 25: alarm 1 (limit1) | 31: programmer output 3 | | |
| 26: alarm 2 (limit2) | 32: programmer output 4 | | |
| 27: alarm 3 (limit3) | 33: program end | | |

16.7.5 Signal output 5 / OUT5

Used for configuring the source of output OUT1.. This signal output can be configured for extensive functions.

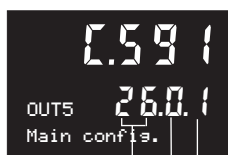

Main configuration:

| Src (Signal source) | | Type (Output stage) | Mode (Actuator output action) |
|--------------------------------|-------------------------|------------------------|---|
| 00: output switched off | 28: alarm 4 (limit4) | 0: relay (switching) | 0: not selectable 1: direct / normally open 2: i nverse / normally closed |
| 01: controller output Y1/Yout1 | 29: programmer output 1 | | |
| 02: controller output Y2/Yout2 | 30: programmer output 2 | | |
| 25: alarm 1 (limit1) | 31: programmer output 3 | | |
| 26: alarm 2 (limit2) | 32: programmer output 4 | | |
| 27: alarm 3 (limit3) | 33: program end | | |

16.7.6 DO5,6 (digital control outputs)

Additional digital control outputs are configured!



Main configuration:
(digital control signal DO5)
Selection is possible with option C fitted.

| Src | Mode |
|-----------------------------------|------------------------------|
| (Digital control signal DO5) | (Actuator output action) |
| 00: output switched off | 0: not selectable |
| 01: controller output Y1 | 1: direct / normally open |
| 34: status automatic=0 / manual=1 | 2: inverse / normally closed |



Main configuration:
(Digital control signal DO6)
Selection is possible with option C fitted.

| Src | Mode |
|------------------------------------|--------------------------------|
| (Digital control signal DO6) | (Motor actuator output action) |
| 00: output switched off | 0: not selectable |
| 02: controller output Y2 | 1: direct / normally open |
| 35: status external=0 / internal=1 | 2: inverse / normally closed |

16.8 ALARM:

16.8.1 Alarm 1 / (limit 1)

The function for alarm 1 is configured.

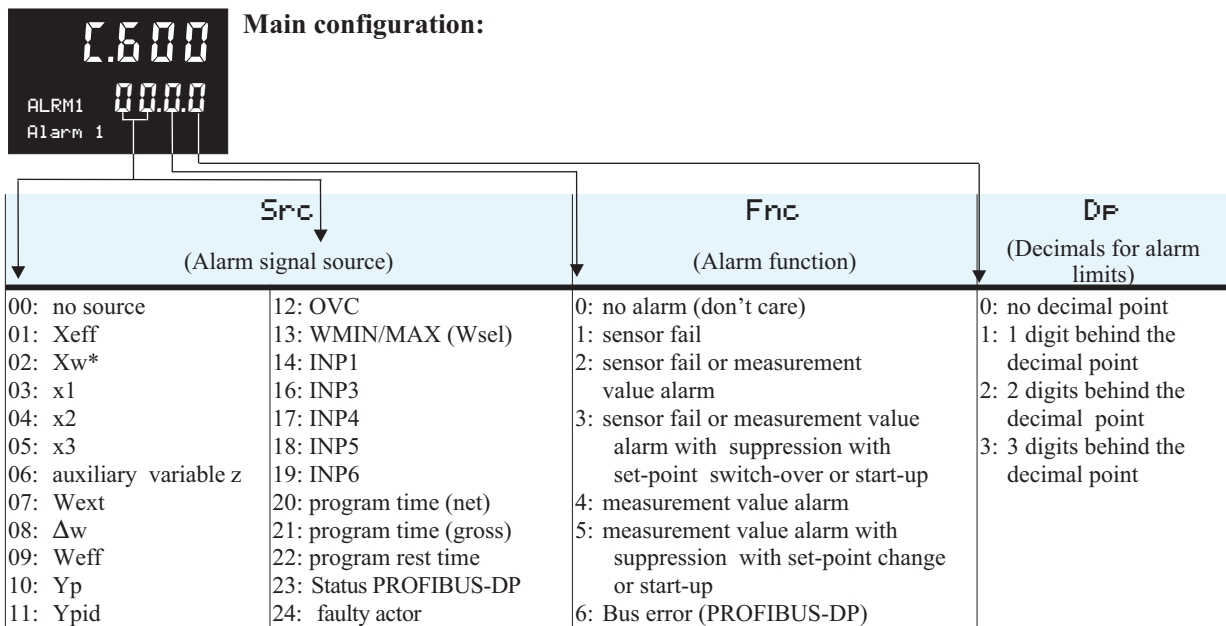

*Limit comparator (referred to set-point), all other versions are fitted with limit contact.

16.8.2 Alarm 2 (limit 2)

The function for alarm 2 is configured.

Main configuration **1.620** see **1.600**

16.8.3 Alarm 3 (limit 3)

The function for alarm 3 is configured.

Main configuration **1.640** see **1.600**

Selection is possible with OUT1 configured as alarm output.

16.8.4 Alarm 4 (limit 4)

The function for alarm 4 is configured.

Main configuration **1.660** see **1.600**

Selection is possible only with OUT2 configured as alarm output

16.9 TUNE: self-tuning

The type of controller self-tuning and the type of controlled self-tuning can be adjusted!

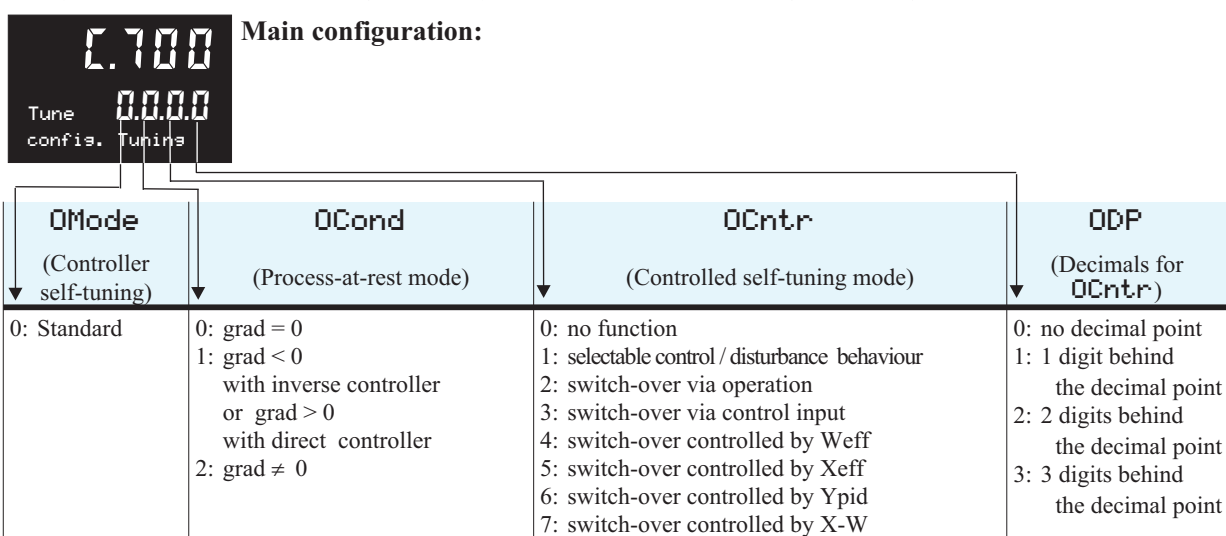

16.10 DISP: User interface for operation

Configuration of display function signification via front panel

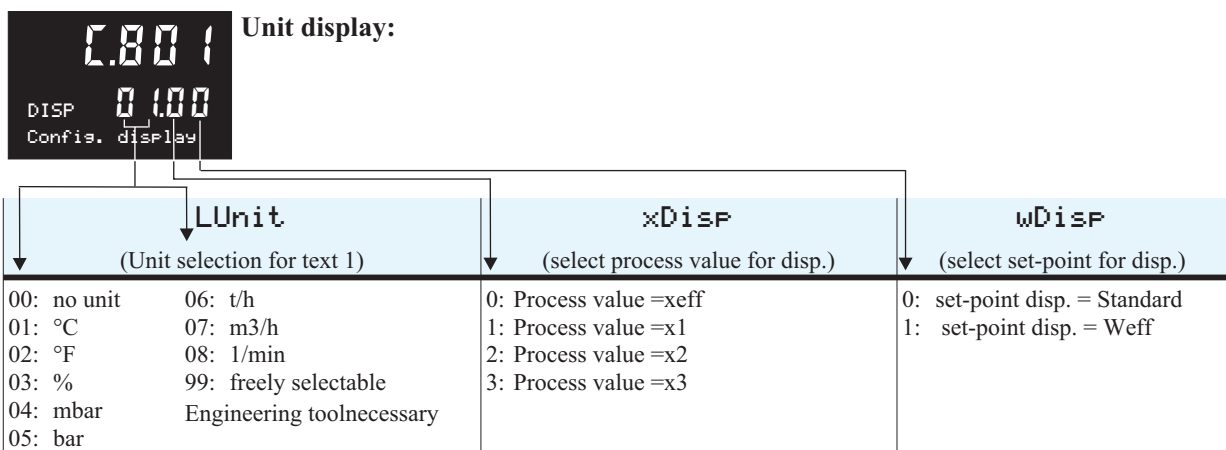
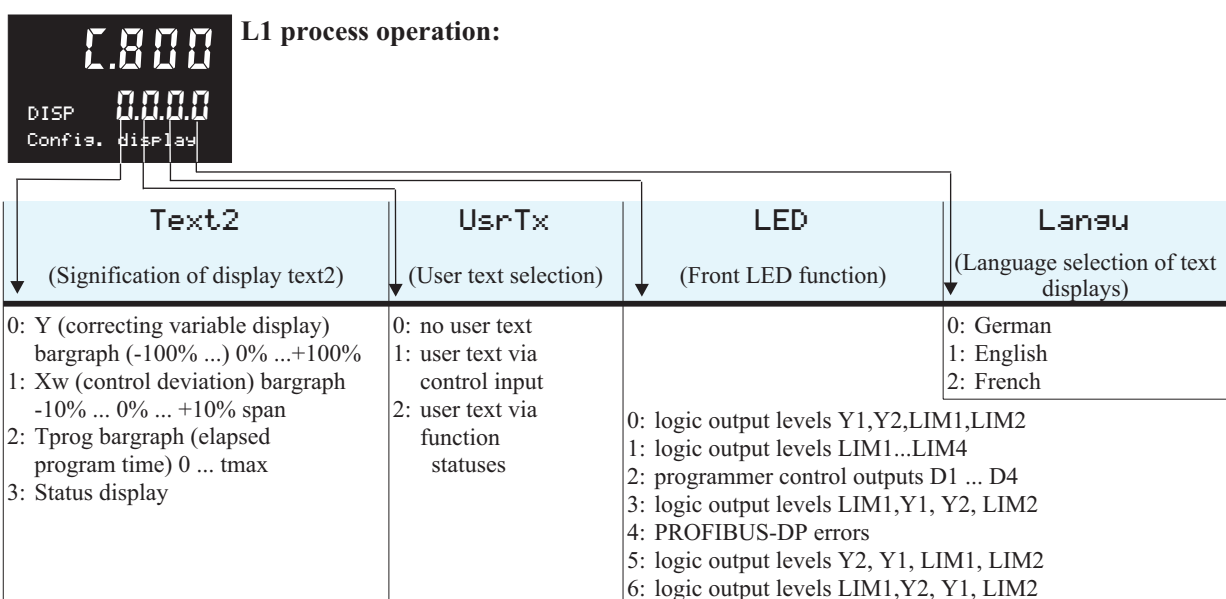

16.11 AUX: Additional functions

The interface function and operating frequency for suppression of interference on inputs are configured.

16.11.1 COM (serial interface)



Main configuration:
(ISO1745, PROFIBUS)
Only with HW option B



| Prot (Interface protocol) | Baud (Baud rate) ¹⁾ |
|------------------------------|-----------------------------------|
| 0: ISO174 | 00: not adjustable |
| | 01: 2400 Bd |
| | 02: 4800 Bd |
| | 03: 9600 Bd |
| | 04: 19200 Bd |

| Addr (Interface address) |
|-----------------------------|
| ISO1745 |
| 0 ... 99 (default 0) |
| PROFIBUS-DP |
| 1...128 (default 128) |

16.11.2 Hardware

The hardware-related functions are configured.



Main configuration:
Operating frequency for suppression of interference on inputs is configured.

| Frq (Mains frequency) |
|-----------------------|
| 0: 50 Hz |
| 1: 60 Hz |

16.11.3 Forcing signal input

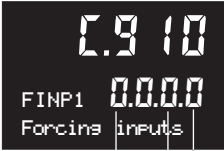

All configuration for forcing ar only present by PROFIBUS-DP



| FINP1 (Forcing input 1) | FINP3 (Forcing input 3) | FINP4 (Forcing input 4) |
|----------------------------|----------------------------|----------------------------|
| 0: Controller value | 0: Controller value | 0: Controller value |
| 1: Forcing | 1: Forcing | 1: Forcing |

| FINP5 (Forcing input 5) | FINP6 (Forcing input 6) |
|----------------------------|----------------------------|
| 0: Controller value | 0: Controller value |
| 1: Forcing | 1: Forcing |

16.11.4 Forcing digital input



| Fdi1 (Forcing digital input 1) | Fdi2 (Forcing digital input 2) | Fdi4 (Forcing digital input 4) |
|-----------------------------------|-----------------------------------|-----------------------------------|
| 0: Controller value | 0: Controller value | 0: Controller value |
| 1: Forcing | 1: Forcing | 1: Forcing |

1) PROFIBUS: automatic baud rate detection

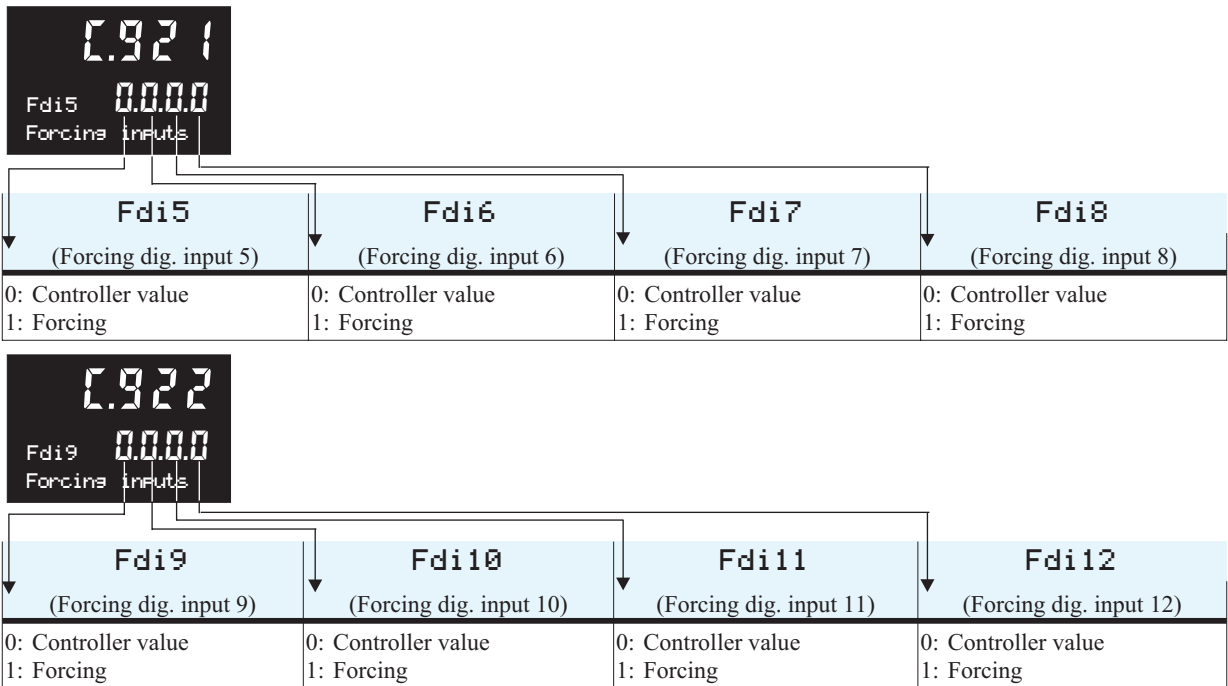

16.11.5 Forcing signal output

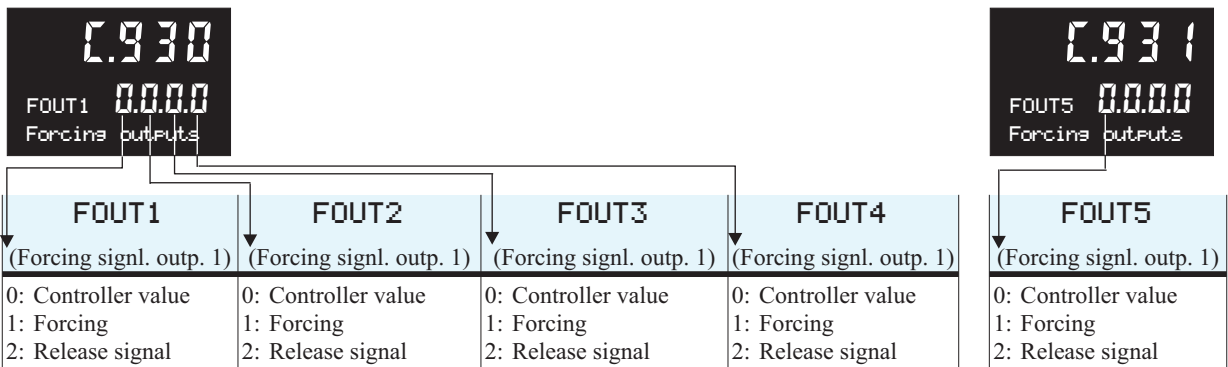

16.11.6 Forcing digital output

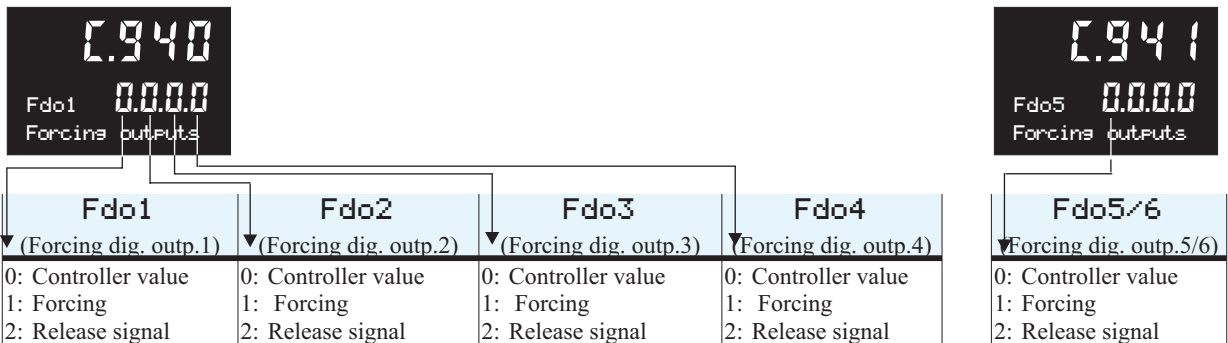

16.11.7 Hard-/Software Codenumber

The following configuration dates are not changeable. They show the hardware version (C.991 u. C.992) and the software version (C.993 u. C.994) of the instrument.

Example: 9407 923 31201

Example: 4012 157 25320

More



16.12 Examples of configuration

| Block diagram | Configuration, different from default | | | |
|---|--|--|--|--|
| <p>9407-9x4-xxxxx</p> <p>Continuous controller 1 xw- alarm, 2 process value alarms</p> | <p>[.100 CFunc = 10 (continuous)</p> <p>[.590 Src = 25 (alarm 1)</p> <p>[.591 Src = 26 (alarm 2)</p> <p>[.200 WFunc = 0, 1, 4 or 5</p> <p>[.600 Src = 02 (xw-alarm)</p> <p>[.500 TYP = sensor type</p> <p>[.660 Src = 03 (process value x1)</p> <p>[.530 Src = 01(controller output y1)</p> <p>[.640 Src = 03 (process value x1)</p> | | | |
| <p>9407-9xx-xxxxx</p> <p>2-pnt. controller + 2 process value alarms</p> | <p>[.100 CFunc = 02 (2-pnt.controller)</p> <p>[.591 Src = 26 (alarm 2)</p> <p>[.660 Src = 03 (process value x1)</p> <p>[.200 WFunc = 0, 1, 4 or 5</p> <p>[.640 Src = 03 (process value x1)</p> <p>[.500 TYP = sensor type</p> <p>[.590 Src = 01(controller output y1)</p> <p>[.590 Src = 25 (alarm 1)</p> | | | |
| <p>9407-9xx-xxxxx</p> <p>3-pnt. stepping controller + process value alarm</p> | <p>[.100 CFunc = 03 (3-pnt.stepping)</p> <p>[.591 Src = 26 (alarm 2)</p> <p>[.620 Src = 03 (process value x1)</p> <p>[.200 WFunc = 0, 1, 4 or 5</p> <p>[.530 TYP = sensor type</p> <p>[.590 Src = 01 (controller output y1)</p> <p>[.590 Src = 02 (controller output y2)</p> | | | |
| <p>9407-9x4-xxxxx</p> <p>Ratio controller (continuous) 1 xw- alarm, 2 process value alarms</p> | <p>[.100 CFunc = 10 (continuous)</p> <p>[.530 Src = 28 (xw-alarm)</p> <p>[.590 Src = 25 (alarm 1)</p> <p>[.591 Src = 26 (alarm 2)</p> <p>[.180 WFunc = 0, 1, 4 or 5</p> <p>[.600 Src = 02 (xw-alarm)</p> <p>[.200 S X2 = 1 (INP5)</p> <p>[.660 Src = 01 (xeff)</p> <p>[.500 TYP = sensor type</p> <p>[.640 Src = 03 (process value x1)</p> <p>[.530 Src = 01(controller output y1)</p> | | | |
| <p>9407-9x4-1x2xx</p> <p>Programmer (continuous) 1 xw- alarm</p> | <p>[.100 CFunc = 10 (continuous)</p> <p>[.530 Src = 28 (alarm 4)</p> <p>[.591 Src = 33 (program end)</p> <p>[.600 Src = 02 (xw-alarm)</p> <p>[.192 WFunc = 3 (programmer)</p> <p>[.200 SPSt = 1 (di4)</p> <p>[.500 TYP = sensor type</p> <p>[.500 Src = 01(controller output y1)</p> | | | |
| <p>9407-9x4-x1xxx</p> <p>Continuous contr. 'split-range' 1 xw- alarm, 1 process value alarm</p> | <p>[.100 CFunc = 11 (continuous split-range)</p> <p>[.590 Src = 25 (alarm 1)</p> <p>[.591 Src = 26 (alarm 2)</p> <p>[.600 Src = 02 (xw-alarm)</p> <p>[.200 WFunc = 0, 1, 4 or 5</p> <p>[.660 Src = 03 (process value x1)</p> <p>[.500 TYP = sensor type</p> <p>[.560 Src = 01(controller output y1)</p> <p>[.560 Src = 02(controller output y2)</p> | | | |

17 Parameters

17.1 General

This section gives a survey of the KS92/94 parameter data and general hints for parameter handling. The parameter operation and effect on the controller operation are described with the operating principle.

The parameter setting dialogue is realized via selector key \square and 'increment' / 'decrement' keys \blacktriangle / \blacktriangledown , like at the other operating levels:

- Press the selector key to select menu items / input values within one level and to change to the next higher level.
- Press the 'increment' / 'decrement' keys to return to a lower level or to change input values.

The controller parameter structure is given on the following page. All parameters are listed. Parameters which are not relevant for a function (configuration-dependent) are not displayed!

A selection menu can be displayed anywhere at parameter level by pressing key \square >3s.

End: return to parameter level
Mark: mark the selected parameter for display at 'extended' configuration level.
Exit: return to operating level.
Conf: transition to configuration level.

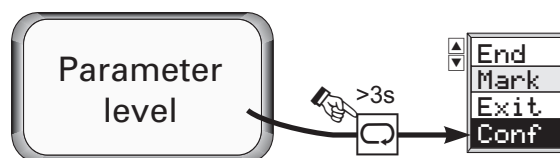

17.1.1 Allocation of parameters to the 'extended operating level'

Up to 12 parameters can be allocated to the 'extended operating level' (see Fig.: 77), whereby the controller operation is simplified, since changing over to parameter level whenever one of these parameters must be changed is omitted.

Allocation: select required parameter, press 'selection' key \square during >3s (**Para** blinks)
 Select Mark with 'up' key \blacktriangle and acknowledge with 'selection' key \square (see Fig.:).

Delete: select the required parameter at the extended operating level, press 'selection' key \square during >3s (**Para** blinks) and acknowledge with 'up' key \blacktriangle .

Select **Clear** and acknowledge with 'selection' key \square (see Fig.:).

Hold: The Hold function can be used for selecting a parameter from the extended operating level for being visible continuously. For this, select the required parameter at the extended operating level, press 'selection' key \square during >3s (**Para** blinks) select Hold with 'up' key \blacktriangle and confirm with 'selection' key \square (see Fig.:).

Applications:

- During optimization, frequent access to defined parameters (Xp1, Xp2, Tn and Tv) is required.
- During commissioning, limit value (LimH1, LimH2, ...) or measurement value corrections must be changed frequently.
- With the parameter level disabled, access to the selected parameters is possible for the operator.
 Deleting a parameter from the 'extended operating level' must be done at this level (see Fig.: 78)

Fig.: 77 Marking a parameter

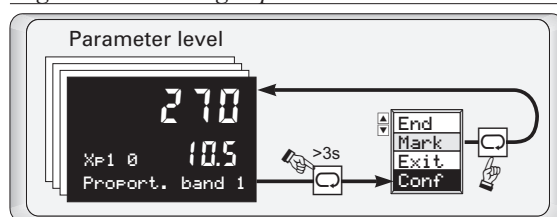
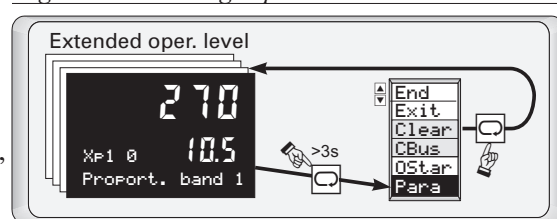

Fig.: 78 Deleting a parameter



17.2 Set-point function

| Text 1 | Description | Range | Default |
|--------------|--|----------------|--------------------|
| SetPt | Set-point parameter | | |
| LC+ | Band width upper limit | 0...9999 | '—' (switched off) |
| LC- | Band width lower limit | 0...9999 | '—' (switched off) |
| W0 | lower set-point limit for Weff | -999 ... 9999 | 0 |
| W100 | upper set-point limit for Weff | -999 ... 9999 | 100 |
| W2 | additional set-point | -999 ... 9999 | 100 |
| Grw+ | set-point gradient plus with W[w/min] | 0.01 ... 99.99 | '—' (switched off) |
| Grw- | set-point gradient minus with W[w/min] | 0.01 ... 99.99 | '—' (switched off) |
| Grw2 | set-point gradient with W2[w/min] | 0.01 ... 99.99 | '—' (switched off) |

17.3 Time function

| Text 1 | Description | Range |
|--------------|-------------------------------|------------------------------|
| Timer | Timer-parameters | |
| TS.Y | Start value: Year | 0...255 |
| TS.MD | Start value: Month and day | Month:1...12; Day: 1...31 |
| TS.HM | Start value: Hour and minutes | Hour:0...23; Minutes: 0...59 |
| TE.Y | Final value: Year | 0...255 |
| TE.MD | Final value: Month and day | Month:1...12; Day: 1...31 |
| TE.HM | Final value: Hour and minutes | Hour:0...23; Minutes: 0...59 |

17.4 Programmer functions

| RecP1 Programmer recipe 1 | | | | | | | |
|---------------------------|------------------------|-------------------------|------|---------|----------------------------------|---------------|------|
| Analog | | | | Digital | | | |
| Text 1 | Description | Range | Def. | Text 1 | Description | Range | Def. |
| Wmode | Change mode | 0: Ramp | 0 | D0 | Reset value control output 1..4 | 0000..1111 | 0000 |
| | | 1: Step | | Td1 | Time segment 1 | 0...9999[min] | '—' |
| | | 2: Ramp (Time priority) | | D1 | control output 1..4 for segm. 1 | 0000..1111 | 0000 |
| Pmode | Preset mode | 0: Segment start | 1 | ... | | | |
| | | 1: Program time | | Td20 | Time segment 20 | 0...9999[min] | '—' |
| Pnext | Successive program | 1..3 or '—' | '—' | D20 | control output 1..4 for segm. 20 | 0000..1111 | 0000 |
| LC- | Band width lower limit | 0...9999 | '—' | | | | |
| LC+ | Band width upper limit | 0...9999 | '—' | | | | |
| Wp0 | Reset value W0 | -999...9999 | 0 | | | | |
| TP1 | Time segment1 | 0...9999 [min] | '—' | | | | |
| WP1 | Set-point segment 1 | -999...9999 | 0 | | | | |
| ... | | | | | | | |
| TP20 | Time segment 20 | 0...9999 [min] | '—' | | | | |
| WP20 | Set-point segment 20 | -999...9999 | 0 | | | | |

RecP2 see programmer recipe 1

RecP3 see programmer recipe 1

17.5 Alarm function

| Text 1 | Description | Range | Default |
|-------------|----------------------|---------------|---------|
| LIM1 | Alarm 1 | | |
| LimL1 | Low limit | -999 ... 9999 | '—' |
| LimH1 | High limit | -999 ... 9999 | '—' |
| Lxsd1 | Switching difference | -999 ... 9999 | 0 |
| LIM2 | Alarm 2 | | |
| LimL2 | Low limit | -999 ... 9999 | '—' |
| LimH2 | High limit | -999 ... 9999 | '—' |
| Lxsd2 | Switching difference | -999 ... 9999 | 0 |
| LIM3 | Alarm 3 | | |
| LimL3 | Low limit | -999 ... 9999 | '—' |
| LimH3 | High limit | -999 ... 9999 | '—' |
| Lxsd3 | Switching difference | -999 ... 9999 | 0 |
| LIM4 | Alarm 4 | | |
| LimL4 | Low limit | -999 ... 9999 | '—' |
| LimH4 | High limit | -999 ... 9999 | '—' |
| Lxsd4 | Switching difference | -999 ... 9999 | 0 |

17.6 Self-tuning

| Text 1 | Description | R/W | Range | Def. |
|--------------------|--|-----|--|------|
| Tune | Optimization | | | |
| YOptm | Correcting variable whilst process at rest | R/W | -105 ... 105 | 0 |
| dYOpt | Step width during identification | R/W | 5 ... 100 | 100 |
| POpt | Parameter set to be optimized | R/W | 0 ... 3 | 1 |
| Tri ^s 1 | trigger point 1 (set 1 ↔ set 2) | R/W | -999 ... 9999 (Decimal point as configured in £.700; ODP) | |
| Tri ^s 2 | trigger point 2 (set 2 ↔ set 3) | R/W | -999 ... 9999 (Decimal point as configured in £.700; ODP) | |
| Tri ^s 3 | trigger point 3 (set 3 ↔ set 4) | R/W | -999 ... 9999 (Decimal point as configured in £.700; ODP) | |
| ORes1 | Self-tuning result during heating | R | 0: Cancellation (during optimization preparation) 1: Cancellation (wrong output action) 2: Finished (successful optimization; reversal point found) 3: Cancellation (process does not react or is too slow) 4: Cancellation (reversal point found; estimation unsafe) 5: Cancellation (reversal point not found; estimation unsafe) 6: Finished (optimization cancelled due to exceeded set-point risk; reversal point not reached so far; estimation unsafe) 7: Cancellation (correcting variable too low $\Delta Y < 5\%$) 8: Cancellation (set-point reserve too low) | |
| ORes2 | Self-tuning result during cooling | R | 0 ... 8 (see ORes1) | |
| Tu1 | Delay time heating | R | 000,0 ... 999,9 s | |
| Vmax1 | Vmax heating | R | 000,0 ... 999,9 /s | |
| KF1 | Process amplification heating | R | 000,0 ... 999,9 | |
| Tu2 | Delay time cooling | R | 000,0 ... 999,9 s | |
| Vmax2 | Vmax cooling | R | 000,0 ... 999,9 /s | |
| KF2 | Process amplification cooling | R | 000,0 ... 999,9 | |

17.7 Control algorithm

| Text 1 | Description | Range | Default |
|--------------|--|---------------------|---------|
| CPara | Controller parameters | | |
| TPuls | Min. pulse length | 0.1 ... 999.9 s | 0.3 |
| Tm | Actuator response time | 10 ... 9999 s | 30 |
| Y2 | Additional correcting value | -105 ... 105 % | 0 |
| Ymin | Min. correcting variable limiting | -105 ... 105 % | 0 |
| Ymax | Max. correcting variable limiting | -105 ... 105 % | 100 |
| Y0 | Correcting variable working point | -105 ... 105 % | 0 |
| ParNr | Actual parameter set | 0 ... 3 | |
| Xsd2 | Switching difference of additional contact | 0.1 ... 999.9 | 1 |
| LW | Trigger point separation of additional contact | -999 ... 9999 | 0 |
| Xsd1 | Switching difference of signaller | 0.1 ... 999.9 | 1 |
| Xsh2 | Neutral zone ($X_w > 0$) | 0.0 ... 999.9 % | 0 |
| Xsh1 | Neutral zone ($X_w < 0$) | 0.0 ... 999.9 % | 0 |
| Xsh | Neutral zone | 0.2 ... 999.9 % | 0.2 |
| Set 0 | Parameter set 0 | | |
| XP1 0 | Proportional band 1 | 0.1 ... 999.9 % | 100 |
| XP2 0 | Proportional band 2 | 0.1 ... 999.9 % | 100 |
| Tn1 0 | Integral action time | 0 ... 9999 s | 10 |
| Tv1 0 | Derivative action time | 0 ... 9999 s | 10 |
| T1 0 | Duty cycle 1 | 0.4 ... 999.9 s | 5 |
| T2 0 | Duty cycle 2 | 0.4 ... 999.9 s | 5 |
| Set1 | Parameter set 1 | | |
| XP1 1 | Proportional band 1 | 0.1 ... 999.9 % | 100 |
| XP2 1 | Proportional band 2 | 0.1 ... 999.9 % | 100 |
| Tn1 1 | Integral action time | 0 ... 9999 s | 10 |
| Tv1 1 | Derivative action time | 0 ... 9999 s | 10 |
| T1 1 | Duty cycle 1 | 0.4 ... 999.9 s | 5 |
| T2 1 | Duty cycle 2 | 0.4 ... 999.9 s | 5 |
| Set2 | Parameter set 2 | | |
| XP1 2 | Proportional band 1 | 0.1 ... 999.9 % | 100 |
| XP2 2 | Proportional band 2 | 0.1 ... 999.9 % | 100 |
| Tn1 2 | Integral action time | 0 ... 9999 s | 10 |
| Tv1 2 | Derivative action time | 0 ... 9999 s | 10 |
| T1 2 | Duty cycle 1 | 0.4 ... 999.9 s | 5 |
| T2 2 | Duty cycle 2 | 0.4 ... 999.9 s | 5 |
| Set3 | Parameter set 3 | | |
| XP1 3 | Proportional band 1 | 0.1 ... 999.9 % | 100 |
| XP2 3 | Proportional band 2 | 0.1 ... 999.9 % | 100 |
| Tn1 3 | Integral action time | 0 ... 9999 s | 10 |
| Tv1 3 | Derivative action time | 0 ... 9999 s | 10 |
| T1 3 | Duty cycle 1 | 0.4 ... 999.9 s | 5 |
| T2 3 | Duty cycle 2 | 0.4 ... 999.9 s | 5 |
| Recov | Rapid Recovery (controller on) | | |
| XwOnY | X-W limit value ($X-W < X_{wOnY} \rightarrow Y$ tracking) | 0 ... 9999 * | '____' |
| XwOnX | X-W limit value ($X-W > X_{wOnX} \rightarrow X$ tracking) | 0 ... 9999 * | '____' |
| GrwOn | set-point gradient with X tracking active | 0,01 ... 99,99 /min | '____' |

* Decimal point position of adjustment range as for main variable X1.

17.8 Input processing**17.8.1 Process value handling**

| Text 1 | Description | Range | Default |
|-------------|-------------------------------------|---------------|---------|
| Istw | | | |
| Tdz | Differentiation time constant for z | 0 ... 9999 s | 10 |
| M0 | Zero offset / ratio | -999 ... 9999 | 0 |
| a | Factor a / 3-element control | -999 ... 9999 | 1 |
| b | Factor b / mean value control | -999 ... 9999 | 0.5 |

17.8.2 Signal pre-processing

| Text 1 | Description | Range | Default |
|--------------|---------------------------------------|---------------|---------|
| INP1 | Signal processing for INP1 | | |
| X1in | Measurement value correction | -999...9999 | 0 |
| X1out | Measurement value correction | -999...9999 | 0 |
| X2in | Measurement value correction | -999...9999 | 100 |
| X2out | Measurement value correction | -999...9999 | 100 |
| m | Scaling: gradient m | 0 ... 9.999 | 1 |
| b | Scaling: offset b | -999 ... 9999 | 0 |
| gain | Square root extraction: gain | 0 ... 9.999 | 1 |
| Tf | Filter: filter time constant | 0 ... 999.9 s | 0.5 |
| INP3 | Signal pre-processing for INP3 | | |
| m3 | Scaling: gradient m | 0 ... 9.999 | 1 |
| b3 | Scaling: offset b | -999 ... 9999 | 0 |
| gain3 | Square root extraction: gain | 0 ... 9.999 | 1 |
| Tf3 | Filter: filter time constant | 0 ... 999.9 s | 1 |
| INP4 | Signal processing for INP4 | | |
| m4 | Scaling: gradient m | 0 ... 9.999 | 1 |
| b4 | Scaling: offset b | -999 ... 9999 | 0 |
| gain4 | Square root extraction: gain | 0 ... 9.999 | 1 |
| Tf4 | Filter: filter time constant | 0 ... 999.9 s | 0.5 |
| INP5 | Signal processing for INP5 | | |
| m5 | Scaling: gradient m | 0 ... 9.999 | 1 |
| b5 | Scaling: offset b | -999 ... 9999 | 0 |
| gain5 | Square root extraction: gain | 0 ... 9.999 | 1 |
| Tf5 | Filter: filter time constant | 0 ... 999.9 s | 0.5 |
| INP6 | Signal processing for INP6 | | |
| m6 | Scaling: gradient m | 0 ... 9.999 | 1 |
| b6 | Scaling: offset b | -999 ... 9999 | 0 |
| gain6 | Square root extraction: gain | 0 ... 9.999 | 1 |
| Tf6 | Filter: filter time constant | 0 ... 999.9 s | 0.5 |

17.9 Miscellaneous

| Text 1 | Description | Range | Def. |
|--------------|---|---|--|
| Aux | General | | |
| Fkey | Function of front panel key  . | 0: no function 1: automatic / manual 2: Wext / Wint | 1 |
| Blck1 | EBloc | extended operating level | 0: free 1: blocked 2: blocked by di1 3: blocked by di2 0 |
| | HBloc | auto/man- key | 0: free 1: blocked 2: blocked by di1 3: blocked by di2 0 |
| | CBloc | controller off | 0: free 1: blocked 2: blocked by di1 3: blocked by di2 0 |
| | WBloc | setpoint | 0: free 1: blocked 2: blocked by di1 3: blocked by di2 0 |
| Blck2 | PBloc | programmer preset | 0: free 1: blocked 2: blocked by di1 3: blocked by di2 0 |
| | RBloc | programmer run/stop/reset | 0: free 1: blocked 2: blocked by di1 3: blocked by di2 0 |
| | OBloc | selftuning | 0: free 1: blocked 2: blocked by di1 3: blocked by di2 0 |

17.10 Signals

| Signal | Description | Range | Def. |
|--------------|---------------------------------------|-----------------|------|
| SetPt | Setpoint signals | | |
| Wint | Internal set-point | | |
| Wext | External set-point | | |
| dWext | External correction | | |
| dW | Set-point offset | -99,9 ... 999,9 | 0 |
| Wsel | Min/max set-point | | |
| Contr | Controller signals | | |
| Y | Correcting value | | |
| YP | Position feedback | | |
| xw | Control deviation | | |
| x1 | Main input x1 | | |
| x2 | Auxillary input x2 | | |
| x3 | Auxillary input x3 | | |
| z | Auxillary variable | | |
| OVC | External correcting variable limiting | | |
| xeff | Effectiv process value | | |
| Input | Input signals | | |
| INP1 | Input 1 | | |
| INP1r | Raw measure 1 | | |
| ... | | | |
| INP6 | Input 6 | | |
| INP6r | Raw measure 6 | | |
| Prog | Programmer signals | | |
| Wp | Programmer setpoint | | |
| tBrut | gross time (inc. all pause times) | | |
| tNet | net time (without pause times) | | |
| tRest | Rest time | | |
| PNr | Programmer no. | 1 ... 3 | 1 |
| Clock | Current time | | |

18.2 Industrial controller KS94



| | | | | | | | |
|---|--|---|---|--|--|--|--|
| POWER SUPPLY AND PROCESS OUTPUTS | KS 94 | 2 | | | | | |
| | KS 94 with two-wire power supply | 3 | | | | | |
| | 90 ... 250 VAC 4 relays (OUT1, OUT2, OUT4, OUT5) | 3 | | | | | |
| | 90 ... 250 VAC 3 relays + current/logic output (OUT1, OUT2, OUT4, OUT5) | 4 | | | | | |
| | 24 V UC 4 relays (OUT1, OUT2, OUT4, OUT5) | 7 | | | | | |
| | 24 V UC 3 relays + current/logic output (OUT1, OUT2, OUT4, OUT5) | 8 | | | | | |
| OPTION B | no interface | | 0 | | | | |
| | TTL-interface, 5 control-inputs (di3 ... di7) and 4 control-outputs (do1 ... do4) | | 1 | | | | |
| | RS422, 5 control-inputs (di3 ... di7) 4 control-outputs (do1 ... do4) and Clock | | 2 | | | | |
| | PROFIBUS-DP, 5 control-inputs (di3 ... di7) and 4 control-outputs (do1 ... do4) | | 3 | | | | |
| | INTERBUS, 5 control-inputs (di3 ... di7) and 4 control-outputs (do1 ... do4) | | 4 | | | | |
| OPTION C | no extension | | 0 | | | | |
| | 2 additional inputs (INP3, INP4), 1 additional output (OUT3) 5 control-inputs (di8 ... di12) and 2 control-outputs (do5, do6) | | 1 | | | | |
| | 1 additional output OUT3 | | 5 | | | | |
| ADDITIONAL FUNCTIONS | no additional function | | 0 | | | | |
| | measured value correction | | 1 | | | | |
| | measured value correction and programmer | | 2 | | | | |
| PRECONFIGURATION | standard setting | | 0 | | | | |
| | 2-point controller | | 1 | | | | |
| | 3-point stepping controller | | 2 | | | | |
| | continuous controller (current/logic output required) | | 3 | | | | |
| | 3-point controller(logic/relay) (current/logic output required) | | 4 | | | | |
| | 3-point stepping controller as 3-element controller (only with additional inputs INP3,INP4) | | 5 | | | | |
| | continuous controller as 3-element controller (only with additional inputs INP3,INP4) | | 6 | | | | |
| | Setting to specification (manual required) | | 9 | | | | |

18.3 Input and output allocation with pre-configured units

The signal (e.g. X1, Y1, alarms) allocation to the inputs and outputs for the relevant pre-configuration (factory setting) is given in the following table. Allocation can be altered at any time via front panel or interface and should be corrected before commissioning, if necessary.

| Order numbers and pre-configured instrument functions | | | | | | | |
|--|--|--|--|--|--|--|---|
| 9407-92(0;3;7)-xxx1x Two-point controller (Relayoutput) | 9407-92(1;4;8)-xxx1x Two-point controller (logicoutput) | 9407-92(0;3;7)-xxx2x Motor-stepping controller | 9407-92(1;4;8)-xxx2x Motor-stepping controller | 9407-92(1;4;8)-xxx3x continuous controller | 9407-92(1;4;8)-xxx4x 3-point controller ("heating"= logic; "cooling" = relay) | 9407-92(3;7)-xxx5x 3-point controller 3-elements controller | 9407-9X(4;8)-xxx6x continuous, 3-elements controller |

Inputs

| | | | | | | | |
|------|-----------------------------------|--|--|------|--------------|--|----|
| INP1 | X1 | | | | | | |
| INP3 | - | | | X2 | - | | X2 |
| INP4 | - | | | | | | X3 |
| INP5 | X2; Wext; Wd | | | Wext | X2; Wext; Wd | | - |
| INP6 | Auxiliary variable 'Z' | | | | | | - |
| di1 | W/Wext | | | | | | |
| di2 | Auto/Man | | | | | | |
| di3 | Local / Remote | | | | | | |
| di4 | Programmer start /stop | | | | | | |
| di5 | Programmer reset | | | | | | |
| di6 | Program selection / Select prg. 1 | | | | | | |
| di7 | Program selection / Select prg. 2 | | | | | | |
| di8 | Select parameter set 1 | | | | | | |
| di9 | Select parameter set 2 | | | | | | |
| di10 | OVC+ (3-pnt stepping) | | | | | | |
| di11 | OVC- (3-pnt stepping) w/dW | | | | | | |
| di12 | Tracking | | | | | | |

Outputs

| | | | | | | | |
|------|---------------------|---|----|----|--------|----|---|
| OUT1 | Y1 | | | - | Y1 | | |
| OUT2 | - | - | Y2 | Y1 | - | Y2 | - |
| OUT3 | Xeff | | | | | | |
| OUT4 | Alarm1 | | | Y2 | Alarm1 | | |
| OUT5 | Alarm2 | | | | | | |
| do1 | Programmer output 1 | | | | | | |
| do2 | Programmer output 2 | | | | | | |
| do3 | Programmer output 3 | | | | | | |
| do4 | Programmer output 4 | | | | | | |
| do5 | Auto/Man | | | | | | |
| do6 | W/Wext | | | | | | |

19 Terminology explanation

Anti-Reset-Wind-Up

A measure which prevents the controller integrator from going into saturation

Working point Y_0

See section from page

The working point of a P or PD controller indicates the correcting variable output to the process with process value = set-point. Although this value is only important for P and PD controllers, it may be of interest also with controllers with integrator (automatic working point).

Automatic operation

See section from page

Normal controller operation. The controller uses the adjusted control parameters for process control. Automatic operation is effective after switching to automatic operation (di1/di2) via a digital input AND selecting automatic operation via front-panel key . Contrary: manual operation

Bandwidth control

See section from page

With program control or gradient control, there may be quite important control deviations due to the process inertia. To prevent these deviations, the control deviation is monitored, in order not to exceed a preset tolerance band. As soon as the control deviation is out of the tolerance band, the set-point change is stopped.

Three-element control

See section from page

Particularly suitable for processes in which load changes would be detected too late (e.g. level control for steam boilers). In this case, a disturbance variable is used at which the mass balance (steam removal, feed water) is evaluated, subtracted and added to the control variable (after differentiation, if necessary).

Feed-forward control

See section from page

Particularly suitable for processes with long delay time, e.g. pH control. An auxiliary variable is used at which the evaluated, differentiated or delayed value of an analog input is added directly to the controller output to avoid the controller time behaviour.

Gradient control

See section from page

Particularly suitable for processes which do not tolerate energy shocks or quick set-point changes. Set-point changes are bumpless in both directions, because the effective set-point always runs towards the changed set-point (target set-point) by means of gradient Grw^+ or Grw^- . For the second set-point w_2 , gradient Grw_2 is effective in both directions, also after switch-over $w \rightarrow w_2$.

Manual operation

See section from page

When switching over to manual operation, the automatic control loop operation is interrupted. Transition between automatic \rightarrow manual and vice versa are bumpless. Manual operation is effective after switching over to manual via a digital input (di1/di2) OR after selecting manual operation via front-panel key . Contrary: automatic.

Cascade control

Particularly suitable for temperature control of e.g. steam boilers. A continuous master controller (load controller) provides its output signal as an external set-point to the cascade controller, which alters the correcting variable.

Override control (OVC)

See section from page

Limitation of the smallest (OVC-) or of the highest (OVC+) correcting variable to the value of an analog input. This limitation control can be used e.g. if control shall be continued by another controller after reaching defined process conditions. Transition from unlimited r limited correcting variable and vice versa are bumpless.

Program control

See section from page

The effective set-point follows the programmer profile. For this, the controller must have been switched to w_{ext} .

Process at rest

See section from page

For a clear *self-tuning* attempt, the control variable must be at rest. Various rest conditions can be selected:

Ramp function

See section from page

Set-point changes are in ramps instead of stepwise. See gradient control.

Rapid Recovery

See section 9.2 from page 59

The controller knows its working point, it can start with the right correcting variable for this working point, i.e. it will return to its working point much earlier.

Control parameters

See section from page

For optimum function, the controller must be matched to the process dynamics. The effective parameters are **Xp1**, **Tn**, **Tv** and **Y0**. Dependent of controller operating principle, the following parameters can be added: **Tp1** (with 2-point/3-point controllers), **Xp2** and **Tp2** (with 3-point controllers), **Xsh** and **Tpuls** and **Tm** (with 3-point stepping controllers).

Control behaviour

See section from page

In general, quick line-out to the set-point without overshoot is an advantage. Dependent of process, various control behaviour types are required:

- Easily controllable processes ($k < 10\%$) can be controlled using PD controllers,
- processes with ($k 10\text{...}22\%$) can be controlled with PID controllers
- and difficult processes ($k > 22\%$) can be controlled with PI controllers.

Controller OFF

With the controller switched off, the switching outputs do not deliver any pulses and the continuous outputs are 0%.

Self-tuning

See section from page

For optimum operation, the controller must be matched to the process requirements. The time required for this can be reduced considerably, whereby the controller uses the process characteristics to determine the *control parameters* for quick line-out the set-point without overshoot.

Soft manual

Normal manual operation: during transition from automatic to manual, the last correcting variable remains active and can be adjusted via keys $\blacktriangle/\blacktriangledown$. The transitions from automatic \rightarrow manual and vice versa are bumpless.

Set-point switch-over

See section from page

In general, the following set-points are possible: internal w_{int} , second internal set-point w_2 and external set-point w_{ext} . With program control, external set-point w_{ext} must be selected. The analog set-point is provided by the programmer.

Correcting variable

See section from page

Particularly suitable for processes where load changes cause process value drops. The set-point (preferential) or process value change is load-dependent. The evaluated and filtered correcting variable is added to the set-point.

PI/P switch-over

During optimization of slow processes, e.g. larges furnaces, the controller I action can cause problems: after start-up optimization, line-out may take a long time. With disturbance behaviour optimization, there may be considerable overshoot. This can be prevented by switching off the I action during start-up or in case of high control deviations (e.g. by means of a limit contact which is effective for the control deviation) and by switching it on again only after the set-point was nearly reached. To prevent a permanent control deviation, the difference between limit contact and set-point must be higher than the permanent control deviation.

Tracking*See section from page*

Switching over from external or program set-point to internal set-point can cause set-point or correcting variable step changes. By using the tracking functions, transition is bumpless.

Process value tracking: after switch-over, the effective process value is stored as internal set-point.

Set-point tracking: after switching over, the external or program set-point used so far is stored as internal set-point.

Ratio control*See section from page*

Particularly suitable for control of mixtures, e.g. fuel-air mixture for ideal or stoichiometric combustion. For taking e.g. the atomizer air into account, zero offset **NO** can be added.

X/xw differentiation

Dynamic changes of process value or set-point affect control in various ways.

- X differentiation : for better control, process value (disturbance) changes are used dynamically to improve control, i.e. the controller disturbance behaviour is used.
- Xw differentiation: Process value (disturbances) and set-point changes are used dynamically to improve the control result, i.e. in this case, the improvement is dependent of both disturbance and control behaviour.

20 Index

| | |
|---|-----|
| A | |
| Alarm processing | 63 |
| Auto/man switch-over | 55 |
| additional functions | 113 |
| B | |
| Bandwidth monitoring | 85 |
| Bumpless switch-over | |
| Auto/man | 55 |
| y-->Y2 | 55 |
| C | |
| Configuration | |
| Outputs | 107 |
| Inputs | 103 |
| Inputsignal allocation | 101 |
| Controller | 99 |
| Structure | 95 |
| Continuous controller | 71 |
| Continuous controller with position control | 72 |
| Control using a disturbance signal | 57 |
| D | |
| Digital inputs | 35 |
| Digital outputs | 38 |
| Display 1 | 19 |
| Display 2 | 19 |
| E | |
| Electrical connections | 13 |
| F | |
| Front view | 19 |
| Function library | |
| Filter (LAG1) | 30 |
| Linearization (CHAR) | 29 |
| Scaling (SCAL) | 29 |
| Square root (SQRT) | 30 |
| G | |
| Galvanic isolation | 25 |
| Gradient function | |
| Grw- | 46 |
| Grw+ | 46 |
| Grw2 | 46 |
| I | |
| Input 0/2...10 V | 33 |
| Input conditioning | |
| Filter | 27 |
| Input circuit monitor | 26 |
| Linearization | 26 |
| Measurement value correction | 28 |
| Scaling | 26 |
| Interface | |
| Switch-over bus -->front panel | 17 |
| Switch-over front panel --> bus | 17 |
| L | |
| Local | 17 |
| M | |
| Mean value | 52 |
| MIN/MAX selection | 48 |
| Mounting | 11 |
| O | |
| Operation | 19 |
| Menu 1..3 | 21 |
| Parameter and configuration level | 21 |
| The operating level | 20 |
| Operation (local) | 17 |
| Output action | 55 |
| Override-control | 54 |
| OVC- | 54 |
| OVC+ | 54 |
| P | |
| PC interface | 17 |
| Process characteristics | 65 |
| Process value tracking | 48 |
| programmer | |
| search mode | 86 |
| Programmer | |
| Change mode ramp/step | 83 |
| control signals and status messages | 84 |
| Parameter entry | 80 |
| Preparation for operation | 83 |
| recipes | 81 |
| R | |
| Rapid Recovery | 59 |
| Ratio controller | 49 |
| Remote | 17 |
| Remote/local | 17 |
| Resistance thermometer | 32 |
| S | |
| Safe set-point W2 | 45 |
| Second set-point W2 | 45 |
| Self-tuning | |
| Messages | 76 |
| Process-at-rest monitoring | 73 |
| Set-point reserve | 73 |
| Sensor break | 56 |
| Set-point tracking | 47 |
| Signal input | |
| INP1 | 31 |
| INP3 | 34 |
| INP4 | 34 |
| INP5 | 34 |
| INP6 | 35 |
| Signal output | |
| OUT1 | 36 |
| OUT2 | 36 |
| OUT3 | 37 |
| OUT4 | 38 |
| OUT5 | 38 |
| Signallers | 66 |
| Standard signal 0/4..20 mA | 33 |
| Status indication | 88 |
| Stoichiometric combustion | 49 |
| T | |
| Thermocouple | 31 |
| Three point stepping controller | 70 |
| Three-element control | 52 |
| Three-point controller | 68 |
| Time | 91 |

| | |
|---|----|
| Tracking | |
| Process value tracking | 48 |
| Set-point tracking | 47 |
| Triangle / star / off | 69 |
| Two-point controller | 67 |
| U | |
| User-defined texts in "Text2" | 93 |
| W | |
| W2 - second set-point | 45 |
| Y | |
| Yp signal | 57 |

Subject to alterations without notice
Änderungen vorbehalten
Sous réserve de toutes modifications

© PMA Prozeß- und Maschinen-Automation GmbH
P.O.B. 310 320, D-34113 Kassel, Germany
Printed in Germany 9499 040 44811 (0005)



9499-040-44811

